

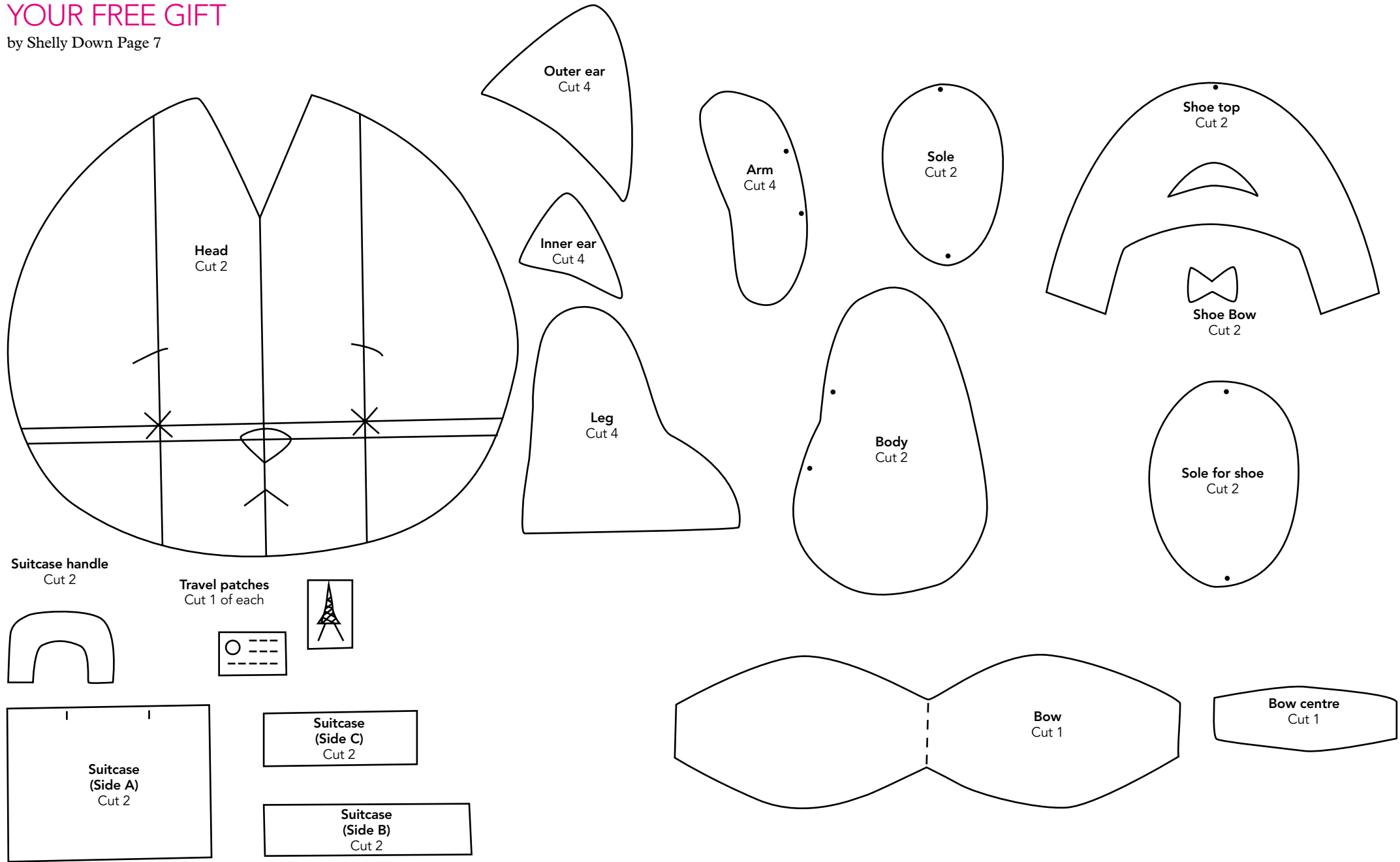

TEMPLATES  
ISSUE 67

# YOUR FREE GIFT

by Shelly Down Page 7



Thank you for making this project from *Mollie Makes*. We have requested specific permission from designers so that you can recreate and sell selected projects from this issue on the following conditions. Just look for this icon.  You can individually hand-make as many as you wish of our labelled projects, to sell either for yourself, your local event or to raise money for charity. You cannot sell in shops (online or otherwise) and you cannot go into mass production, which means you cannot manufacture in large quantities, especially by machine. Selling photocopies of any part of this magazine, its kits or supplements is prohibited. We don't mind if you make a copy of the templates for a friend but please do not make any part of the templates or instructions available to others through your website or a third party website, or copy it multiple times without our permission. Please respect one another's copyright.

# YOUR FREE GIFT

by Shelly Down Page 7

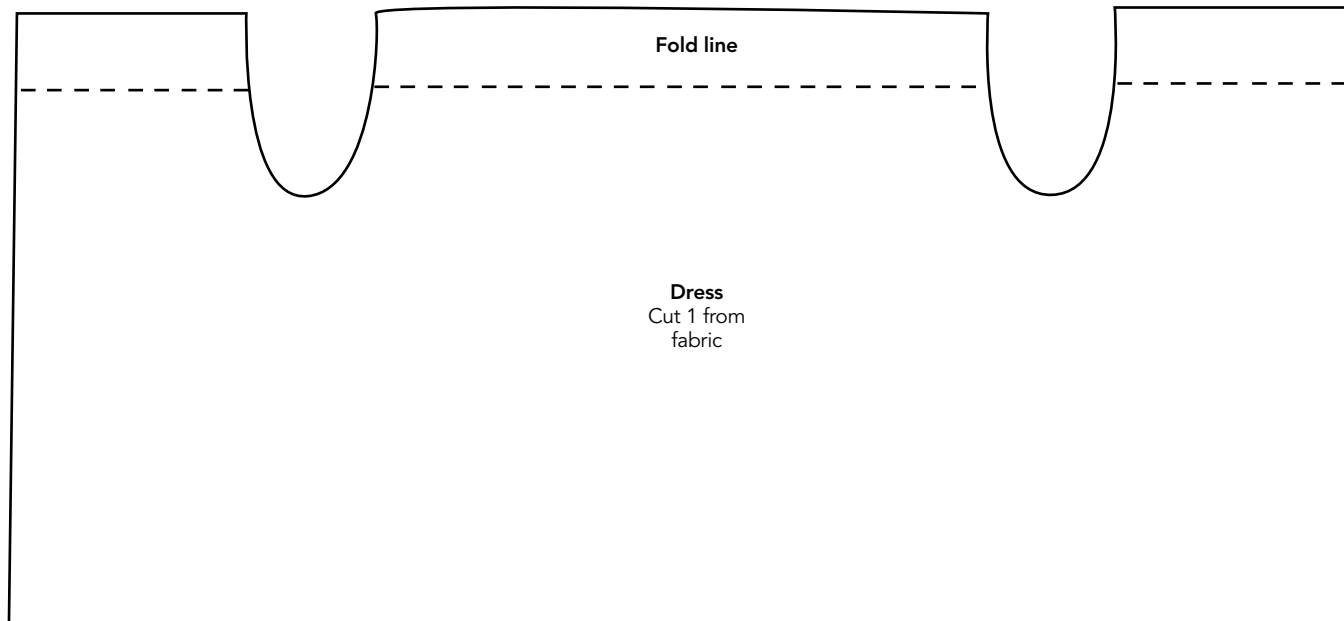

Pattern layout 2 (brown felt)  
Shoes and suitcase

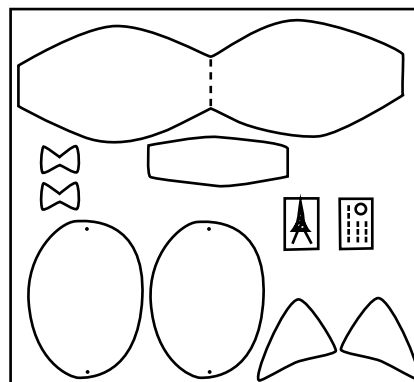
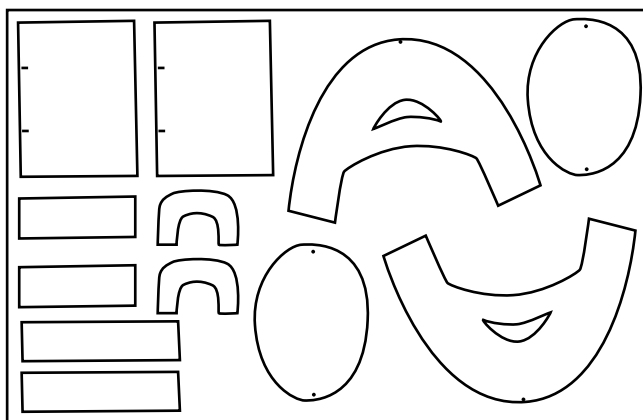

Pattern layout 3  
(pink felt)  
Bow, inner ears, foot pads and travel stickers

Pattern layout 1 (beige felt)  
Head and body

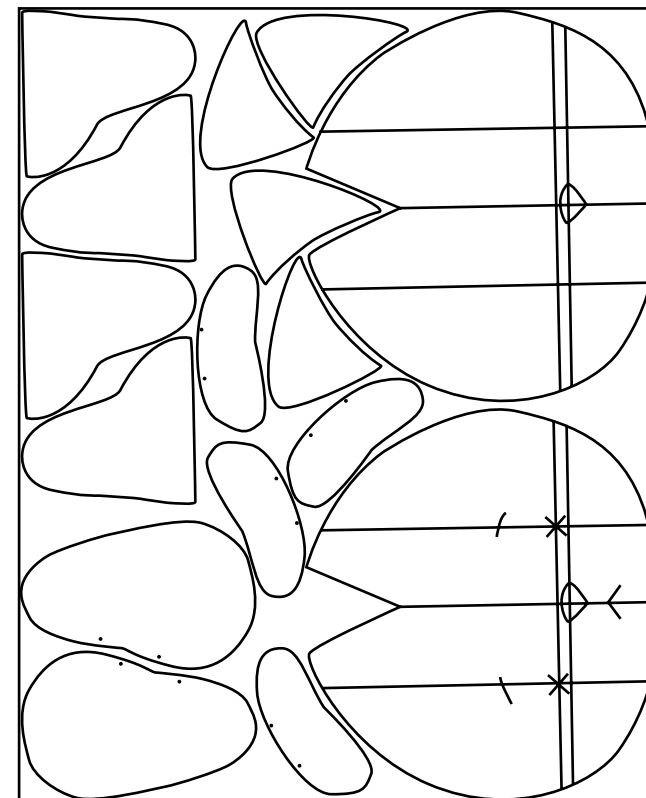

Thank you for making this project from *Mollie Makes*. We have requested specific permission from designers so that you can recreate and sell selected projects from this issue on the following conditions. Just look for this icon.  You can individually hand-make as many as you wish of our labelled projects, to sell either for yourself, your local event or to raise money for charity. You cannot sell in shops (online or otherwise) and you cannot go into mass production, which means you cannot manufacture in large quantities, especially by machine. Selling photocopies of any part of this magazine, its kits or supplements is prohibited. We don't mind if you make a copy of the templates for a friend but please do not make any part of the templates or instructions available to others through your website or a third party website, or copy it multiple times without our permission. Please respect one another's copyright.

# PRINTED HANKERCHEIFS

by Zeena Shah Page 81



# ICE CREAM MAGNETS

by Little Button Diaries Page 96

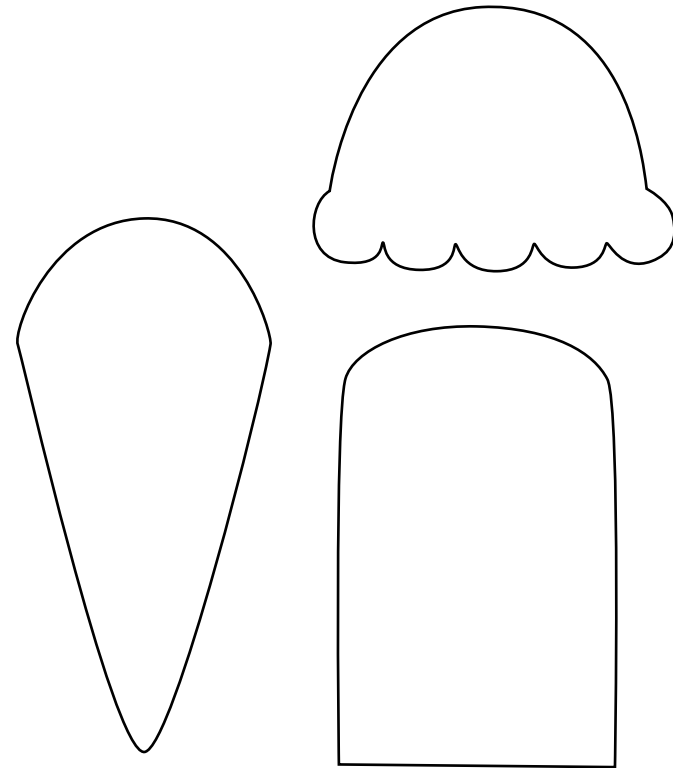

Thank you for making this project from *Mollie Makes*. We have requested specific permission from designers so that you can recreate and sell selected projects from this issue on the following conditions. Just look for this icon.  You can individually hand-make as many as you wish of our labelled projects, to sell either for yourself, your local event or to raise money for charity. You cannot sell in shops (online or otherwise) and you cannot go into mass production, which means you cannot manufacture in large quantities, especially by machine. Selling photocopies of any part of this magazine, its kits or supplements is prohibited. We don't mind if you make a copy of the templates for a friend but please do not make any part of the templates or instructions available to others through your website or a third party website, or copy it multiple times without our permission. Please respect one another's copyright.

# MONSTER BAG

by Mafalda Nobre Page 93

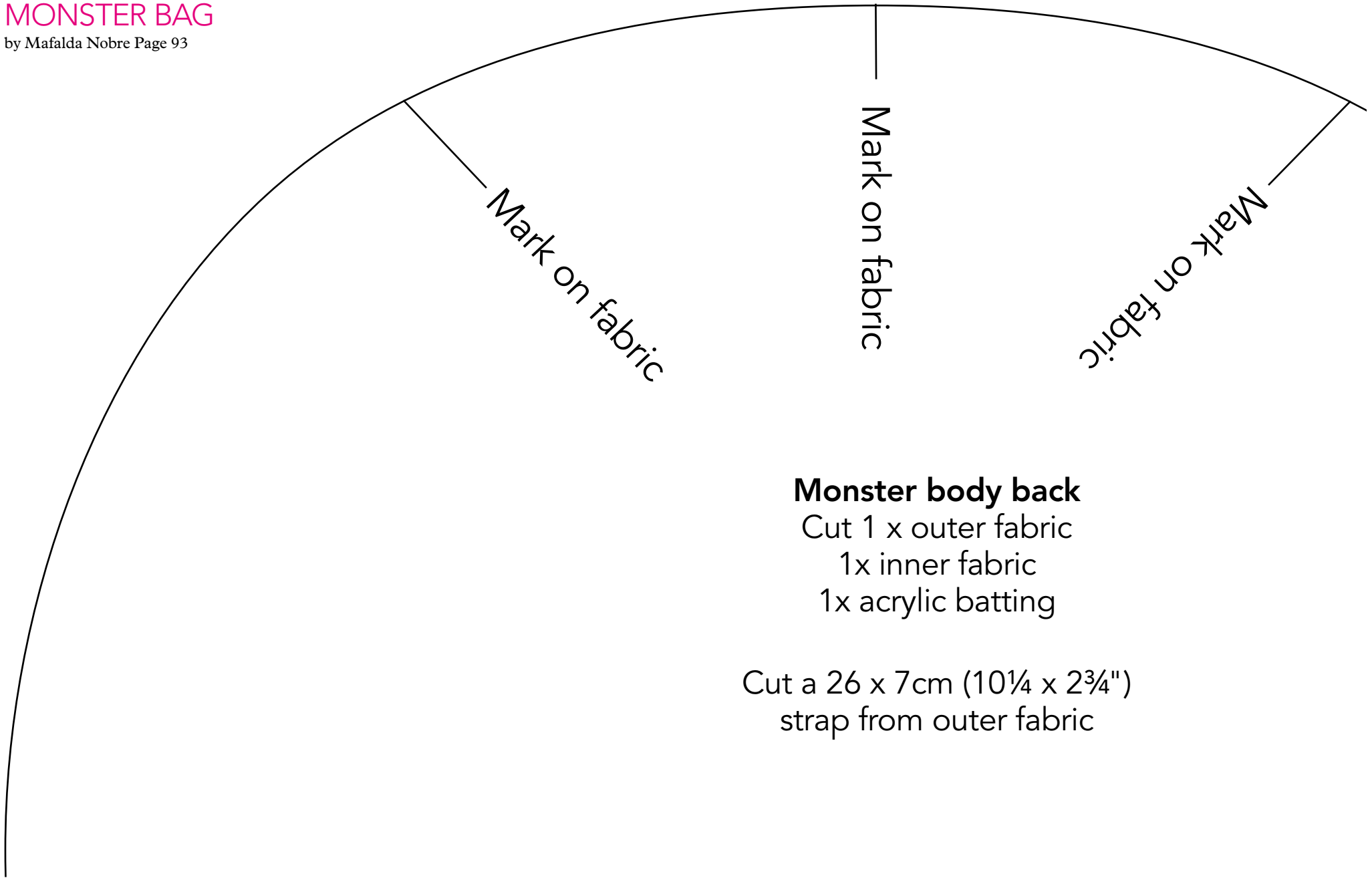

## Monster body back

Cut 1 x outer fabric

1x inner fabric

1x acrylic batting

Cut a 26 x 7cm (10¼ x 2¾")  
strap from outer fabric

# MONSTER BAG

by Mafalda Nobre Page 93



**Monster body back**



## Monster body back

## MONSTER BAG

by Mafalda Nobre Page 93

Thank you for making this project from *Mollie Makes*. We have requested specific permission from designers so that you can recreate and sell selected projects from this issue on the following conditions. Just look for this icon.  You can individually hand-make as many as you wish of our labelled projects, to sell either for yourself, your local event or to raise money for charity. You cannot sell in shops (online or otherwise) and you cannot go into mass production, which means you cannot manufacture in large quantities, especially by machine. Selling photocopies of any part of this magazine, its kits or supplements is prohibited. We don't mind if you make a copy of the templates for a friend but please do not make any part of the templates or instructions available to others through your website or a third party website, or copy it multiple times without our permission. Please respect one another's copyright.

**Monster body back**

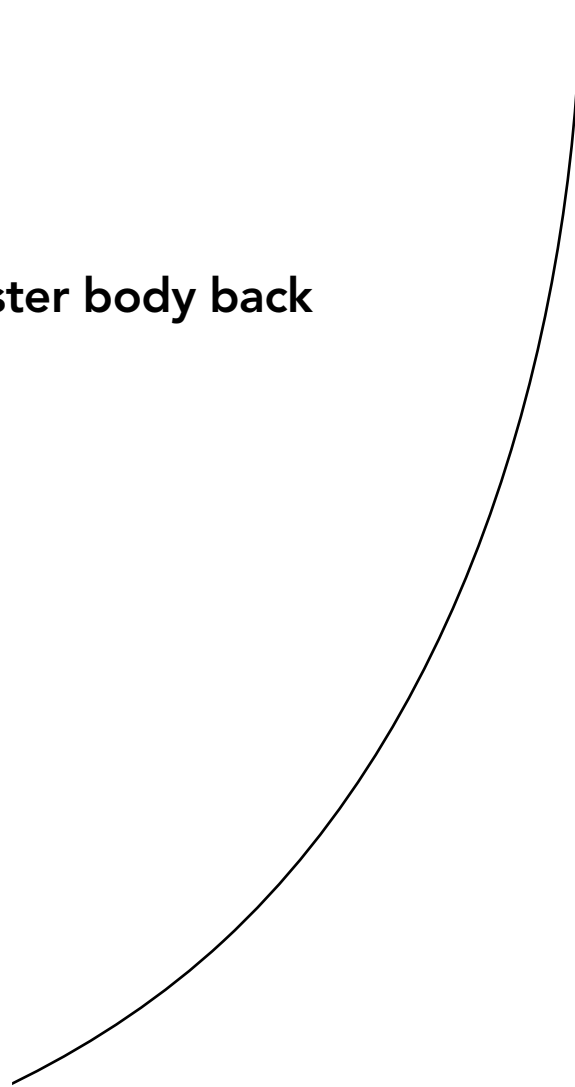

**Ear**

Cut 4 x inner fabric  
2 x acrylic batting

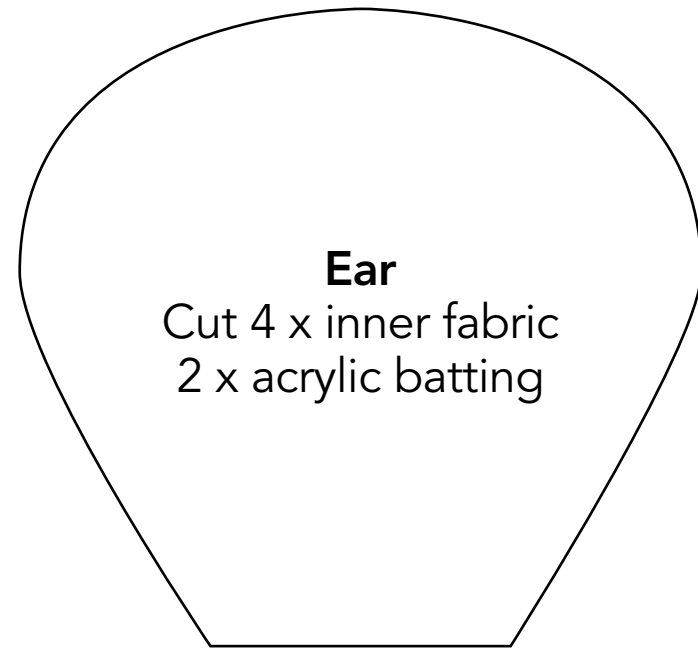



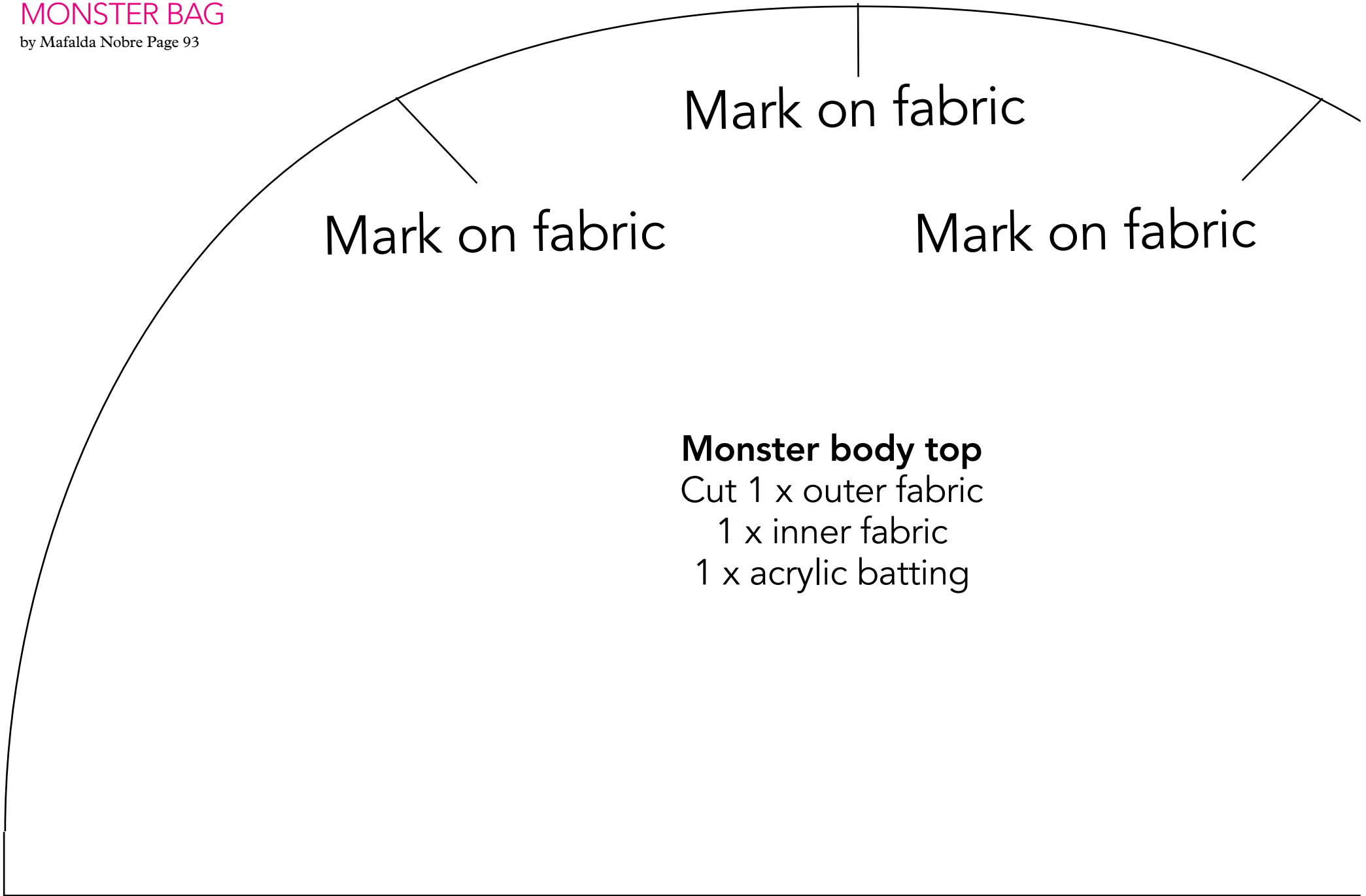

Mark on fabric

Mark on fabric

Mark on fabric

## Monster body top

Cut 1 x outer fabric

1 x inner fabric

1 x acrylic batting

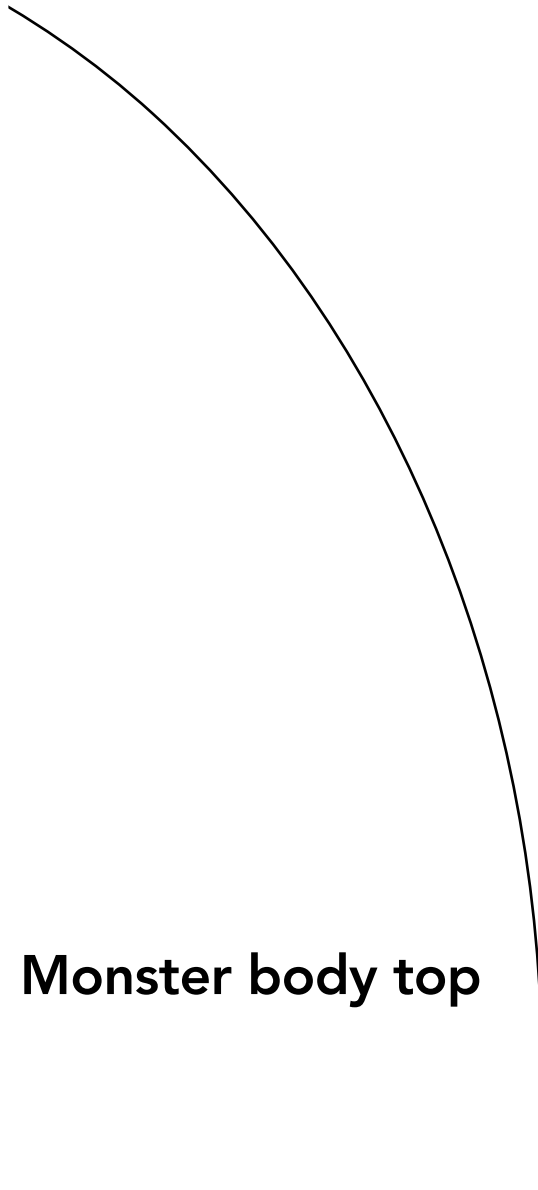

**Monster body top**



## Monster body bottom

Cut 1 x outer fabric

1 x inner fabric

1 x acrylic batting

# MONSTER BAG

by Mafalda Nobre Page 93

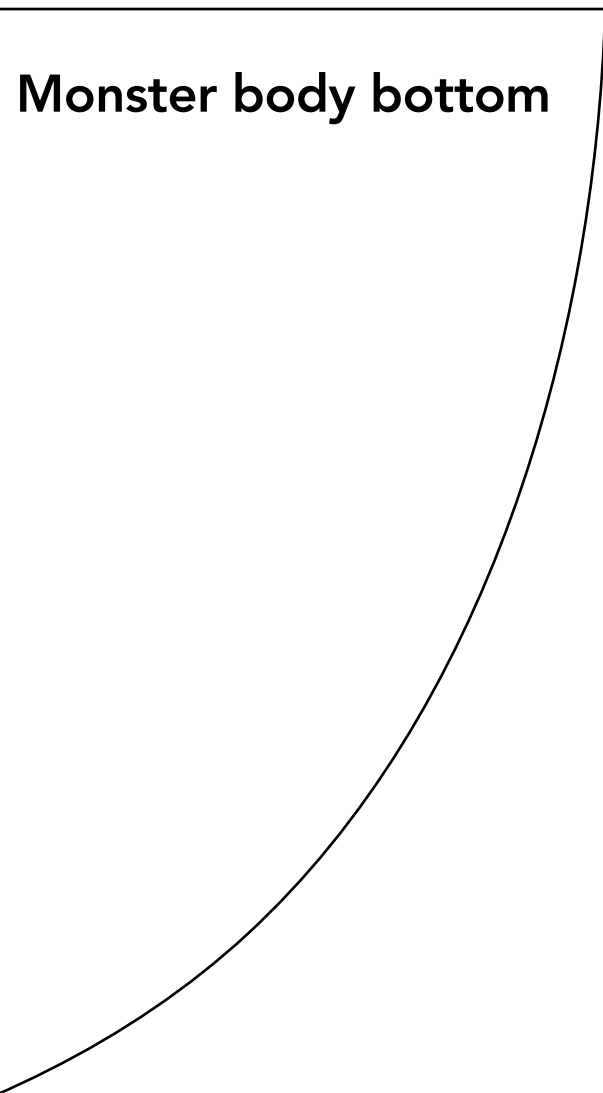

Thank you for making this project from *Mollie Makes*. We have requested specific permission from designers so that you can recreate and sell selected projects from this issue on the following conditions. Just look for this icon.  You can individually hand-make as many as you wish of our labelled projects, to sell either for yourself, your local event or to raise money for charity. You cannot sell in shops (online or otherwise) and you cannot go into mass production, which means you cannot manufacture in large quantities, especially by machine. Selling photocopies of any part of this magazine, its kits or supplements is prohibited. We don't mind if you make a copy of the templates for a friend but please do not make any part of the templates or instructions available to others through your website or a third party website, or copy it multiple times without our permission. Please respect one another's copyright.

# SUBS CLUB BUM BAG

by Amy Phipp Page 24

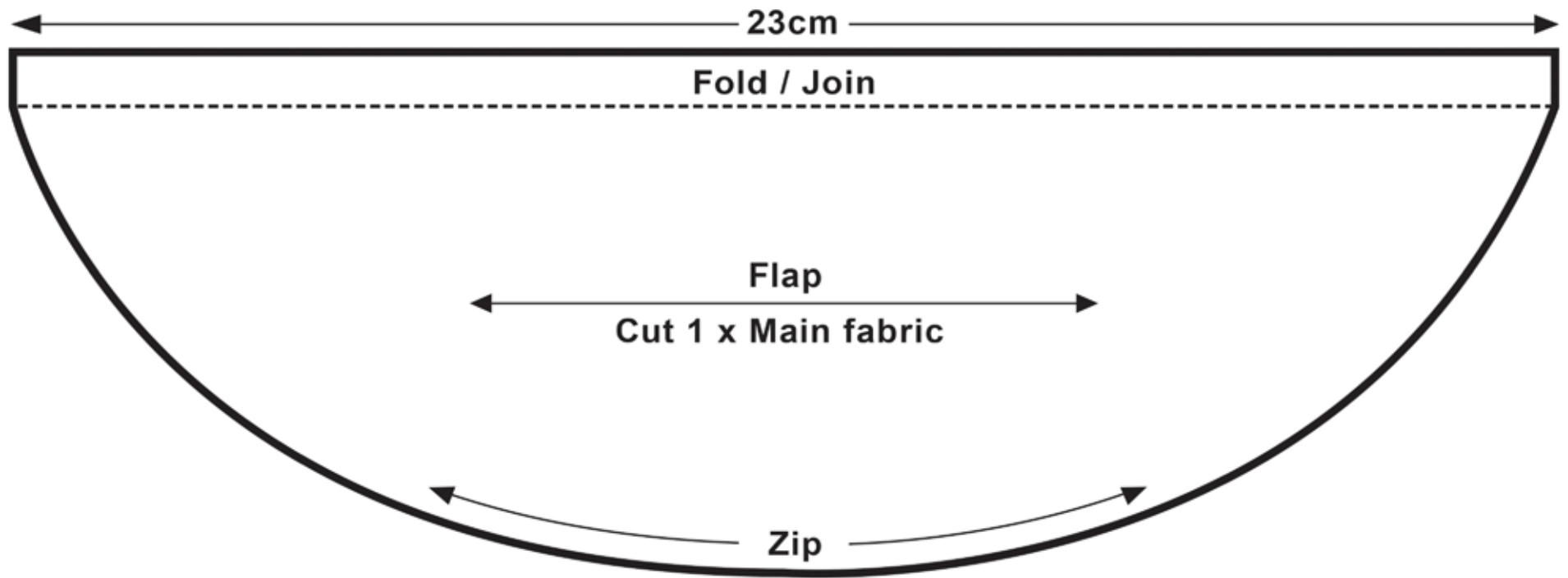

Thank you for making this project from *Mollie Makes*. We have requested specific permission from designers so that you can recreate and sell selected projects from this issue on the following conditions. Just look for this icon.  You can individually hand-make as many as you wish of our labelled projects, to sell either for yourself, your local event or to raise money for charity. You cannot sell in shops (online or otherwise) and you cannot go into mass production, which means you cannot manufacture in large quantities, especially by machine. Selling photocopies of any part of this magazine, its kits or supplements is prohibited. We don't mind if you make a copy of the templates for a friend but please do not make any part of the templates or instructions available to others through your website or a third party website, or copy it multiple times without our permission. Please respect one another's copyright.

# SUBS CLUB BUM BAG

by Amy Phipp Page 24

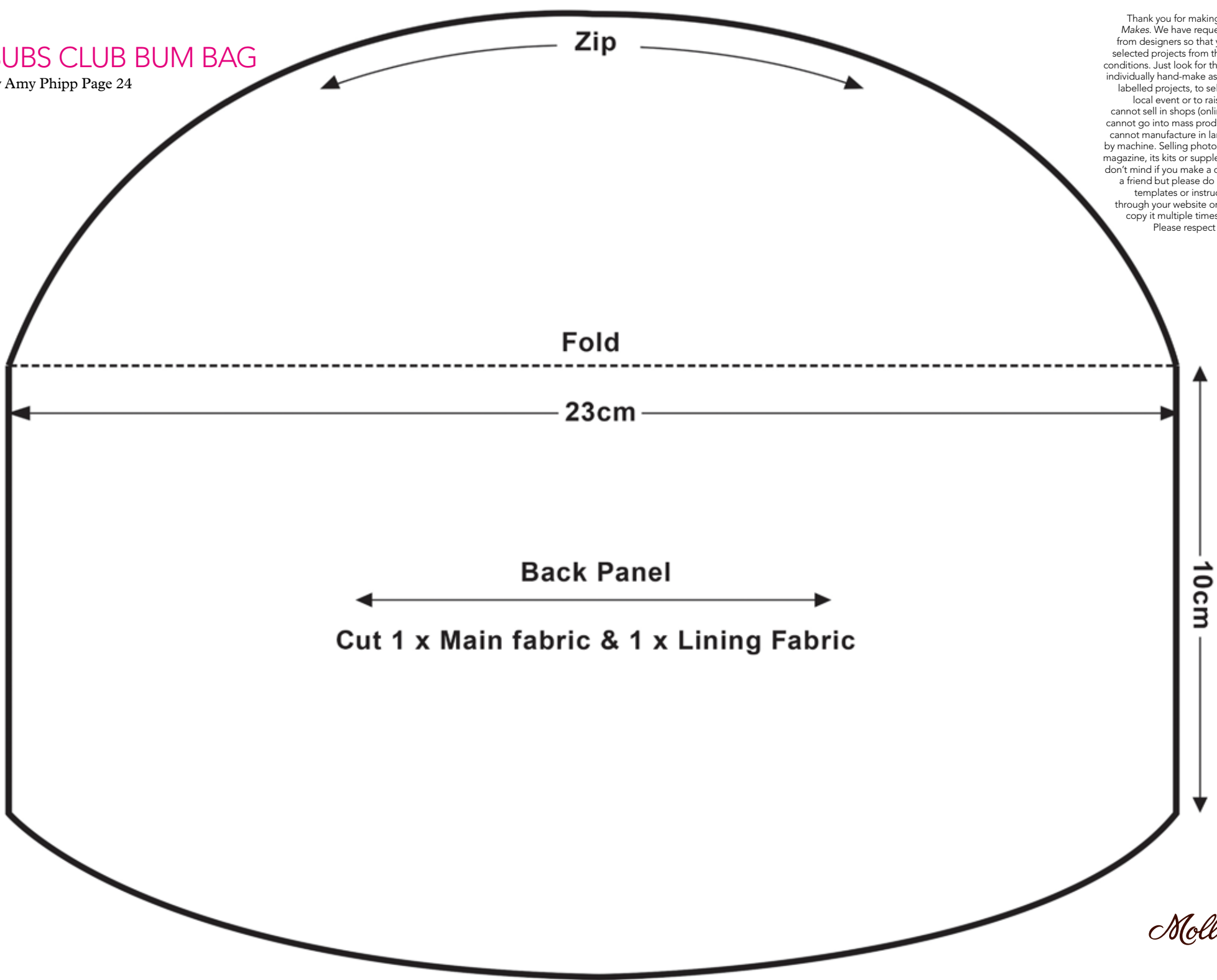

Thank you for making this project from *Mollie Makes*. We have requested specific permission from designers so that you can recreate and sell selected projects from this issue on the following conditions. Just look for this icon. You can individually hand-make as many as you wish of our labelled projects, to sell either for yourself, your local event or to raise money for charity. You cannot sell in shops (online or otherwise) and you cannot go into mass production, which means you cannot manufacture in large quantities, especially by machine. Selling photocopies of any part of this magazine, its kits or supplements is prohibited. We don't mind if you make a copy of the templates for a friend but please do not make any part of the templates or instructions available to others through your website or a third party website, or copy it multiple times without our permission. Please respect one another's copyright.

# SUBS CLUB BUM BAG

by Amy Phipp Page 24

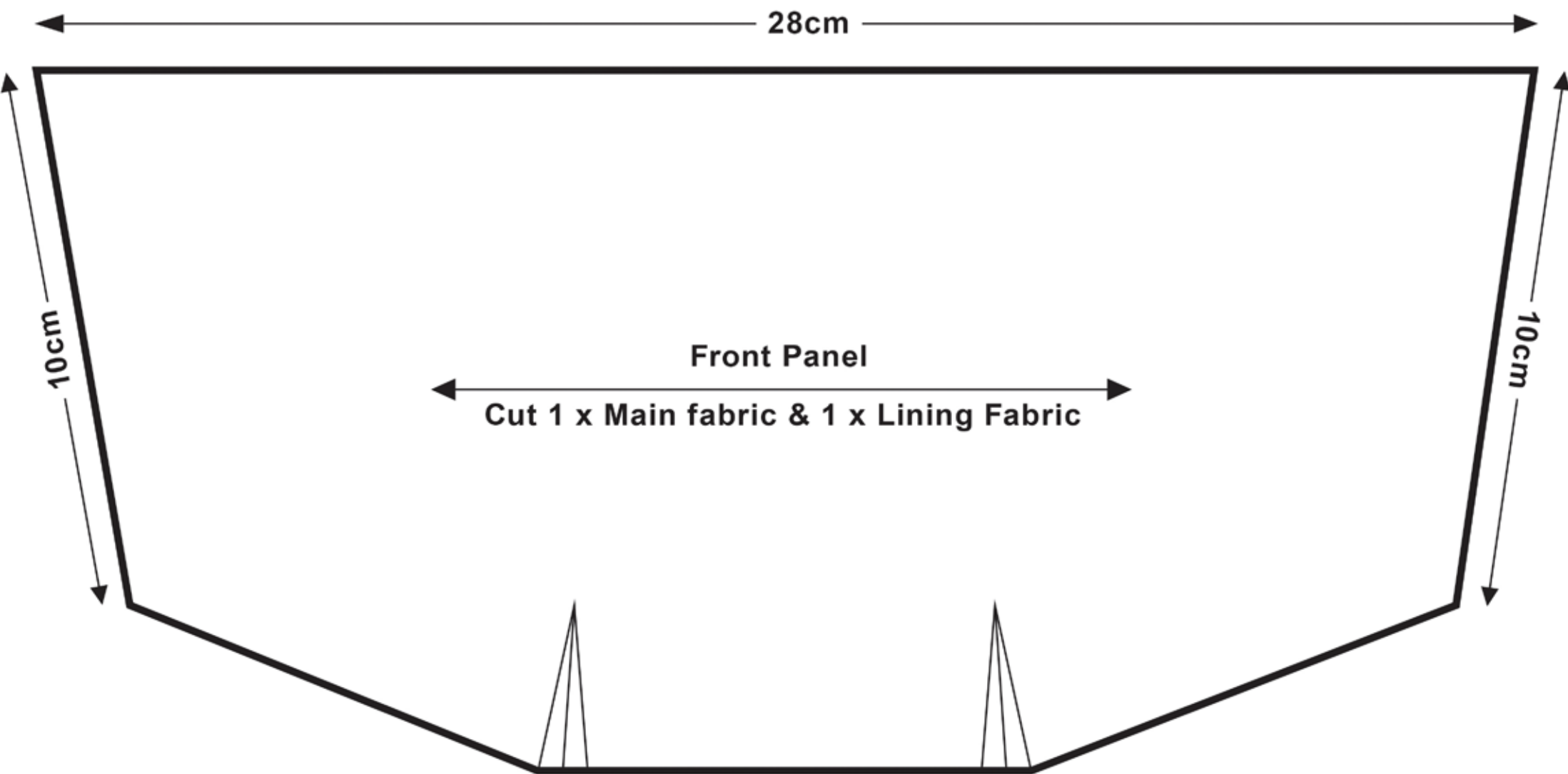

Thank you for making this project from *Mollie Makes*. We have requested specific permission from designers so that you can recreate and sell selected projects from this issue on the following conditions. Just look for this icon.  You can individually hand-make as many as you wish of our labelled projects, to sell either for yourself, your local event or to raise money for charity. You cannot sell in shops (online or otherwise) and you cannot go into mass production, which means you cannot manufacture in large quantities, especially by machine. Selling photocopies of any part of this magazine, its kits or supplements is prohibited. We don't mind if you make a copy of the templates for a friend but please do not make any part of the templates or instructions available to others through your website or a third party website, or copy it multiple times without our permission. Please respect one another's copyright.