



TEMPLATES
ISSUE 41

create

MAKE ME A MIXTAPE

By Laura Howard Page 20

iPod & iPhone version

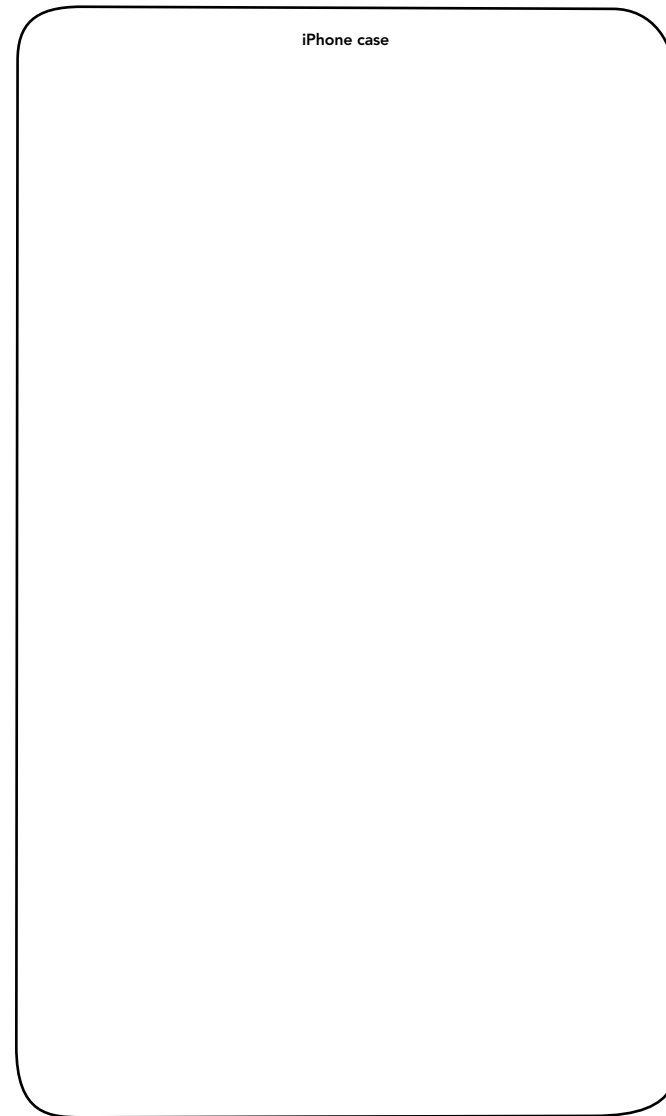
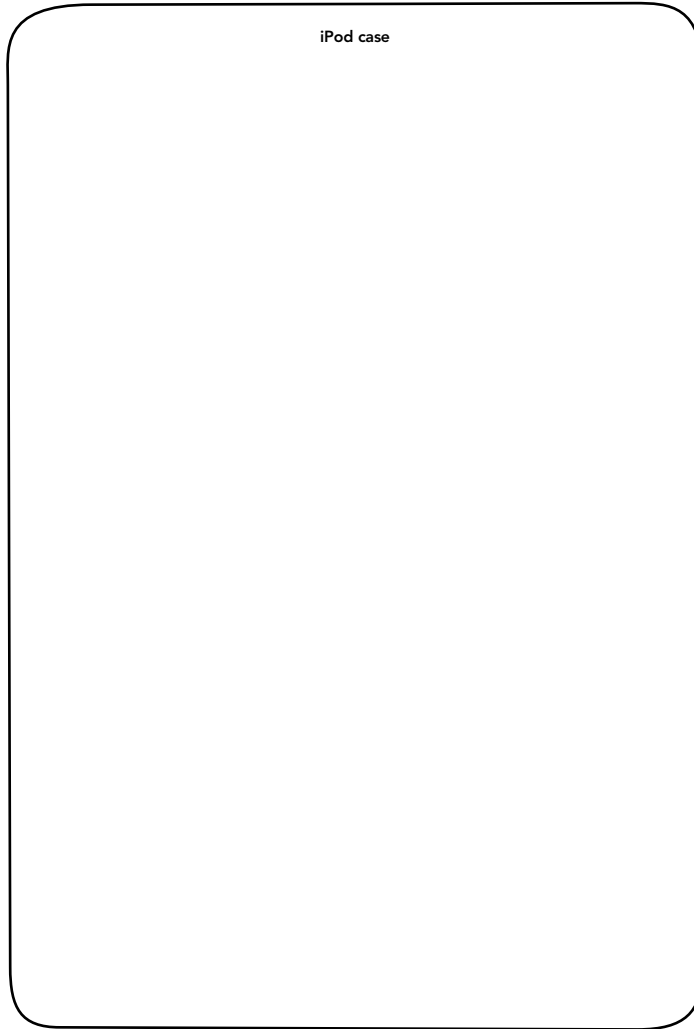

MAKE ME A MIXTAPE

By Laura Howard Page 20

iPod & iPhone version

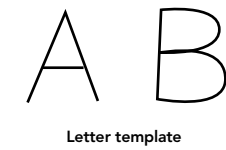
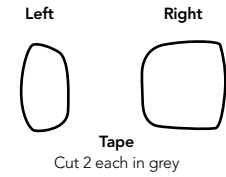
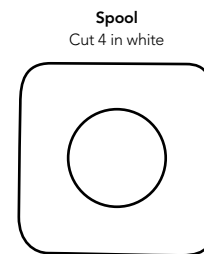
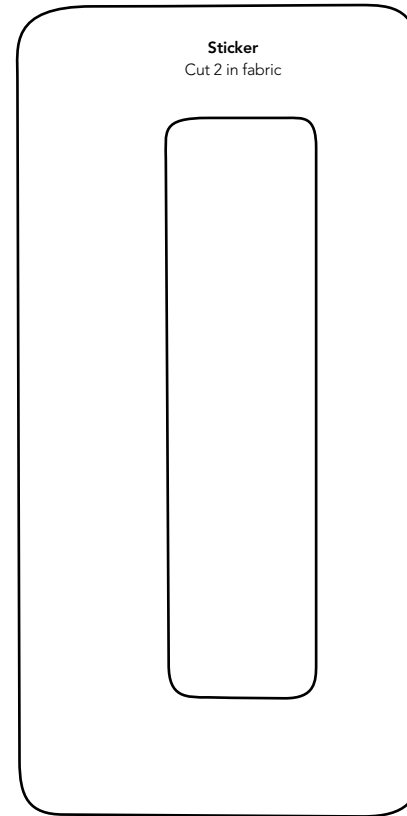
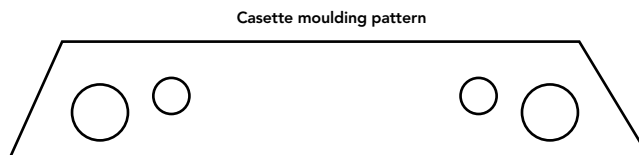
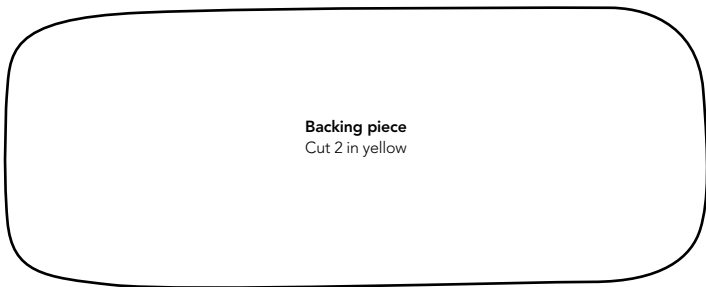
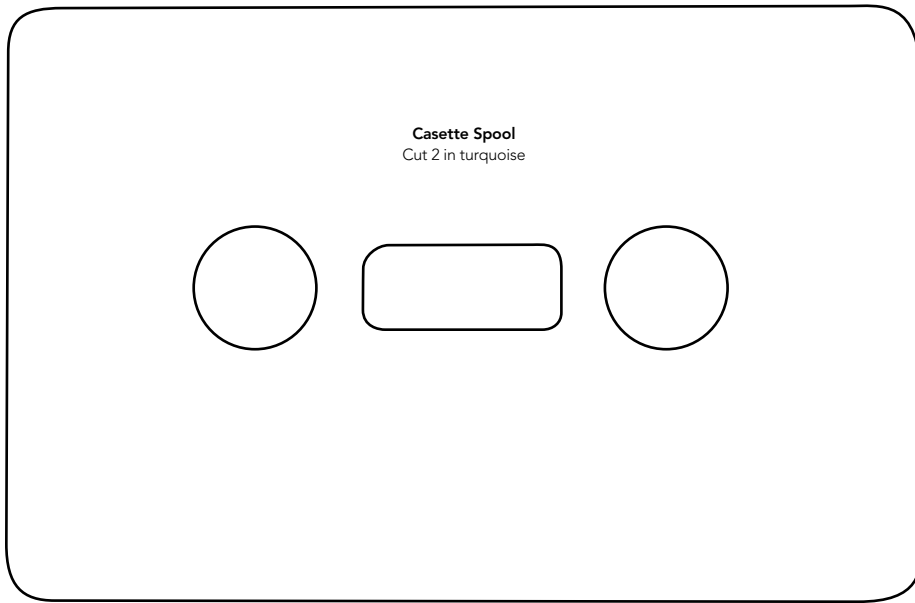

Rainbow template
Add to sticker

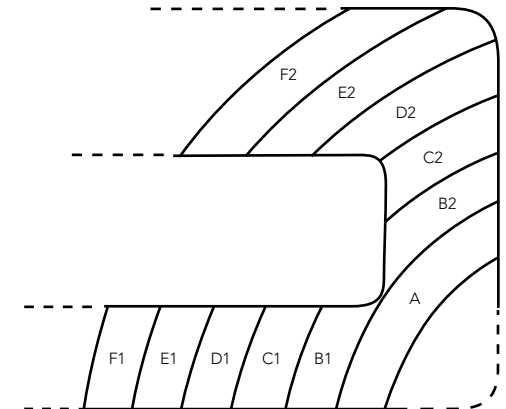

MAKE ME A MIXTAPE

By Laura Howard Page 20

iPad version

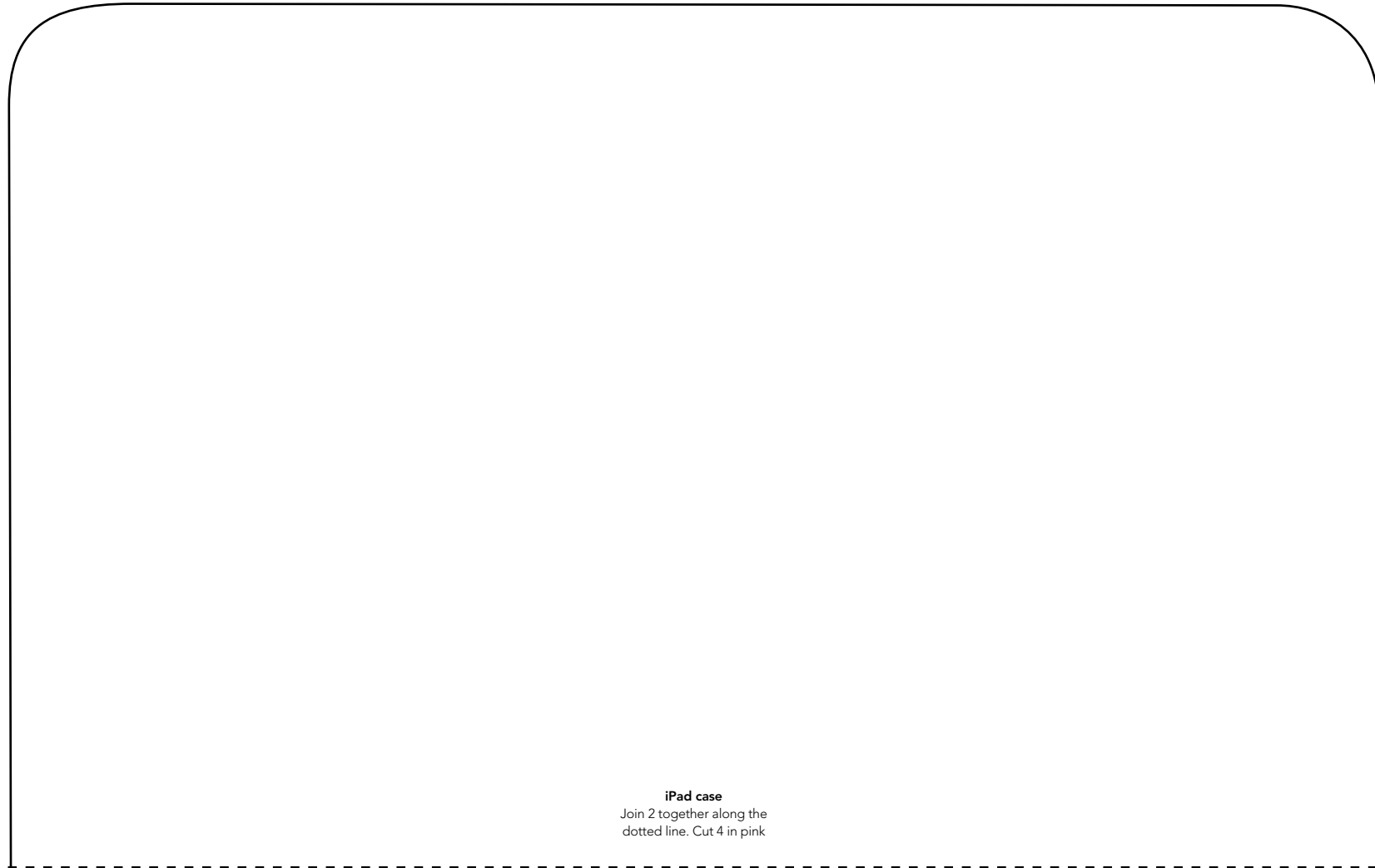

iPad case
Join 2 together along the
dotted line. Cut 4 in pink

MAKE ME A MIXTAPE

By Laura Howard Page 20

iPad version

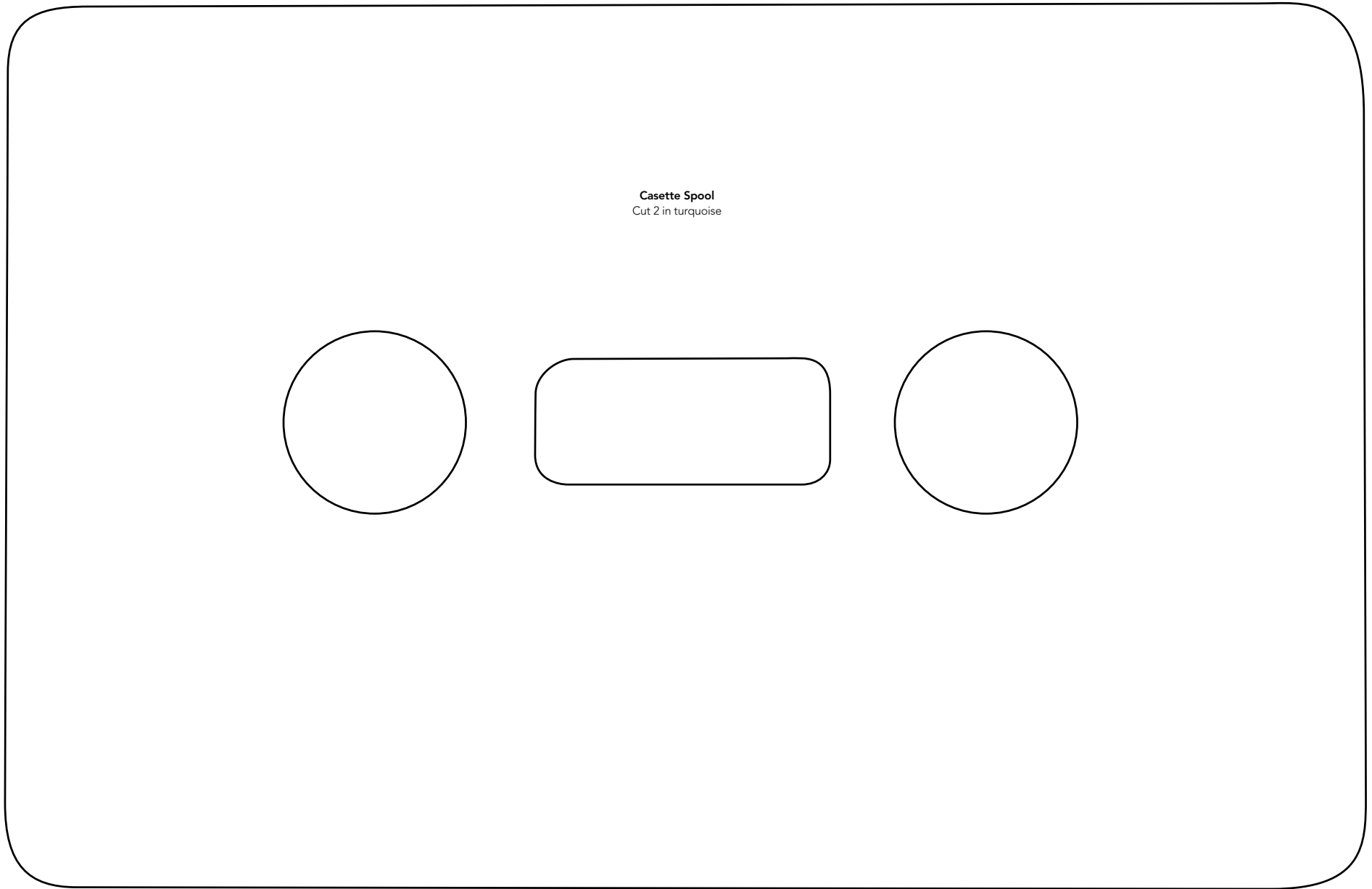

MAKE ME A MIXTAPE

By Laura Howard Page 20

iPad version

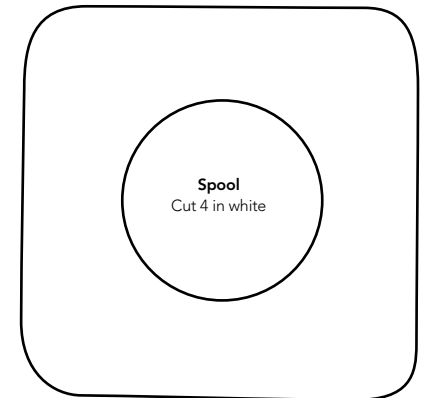
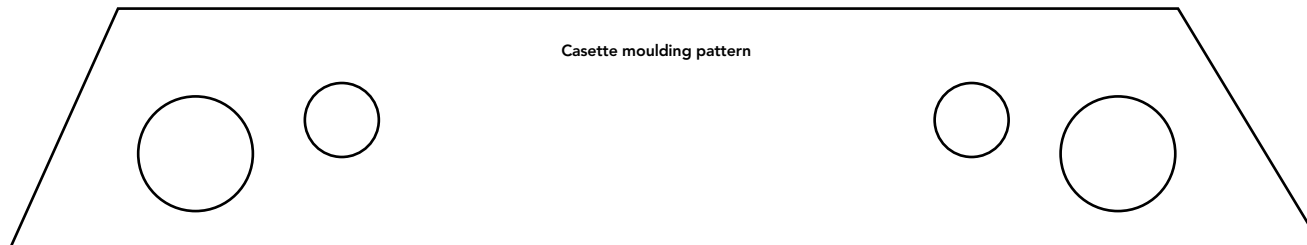
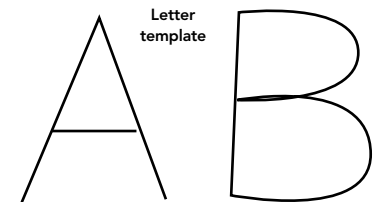
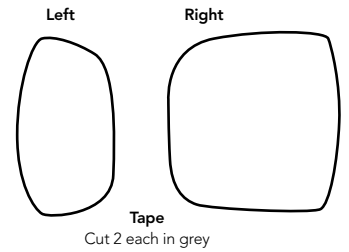
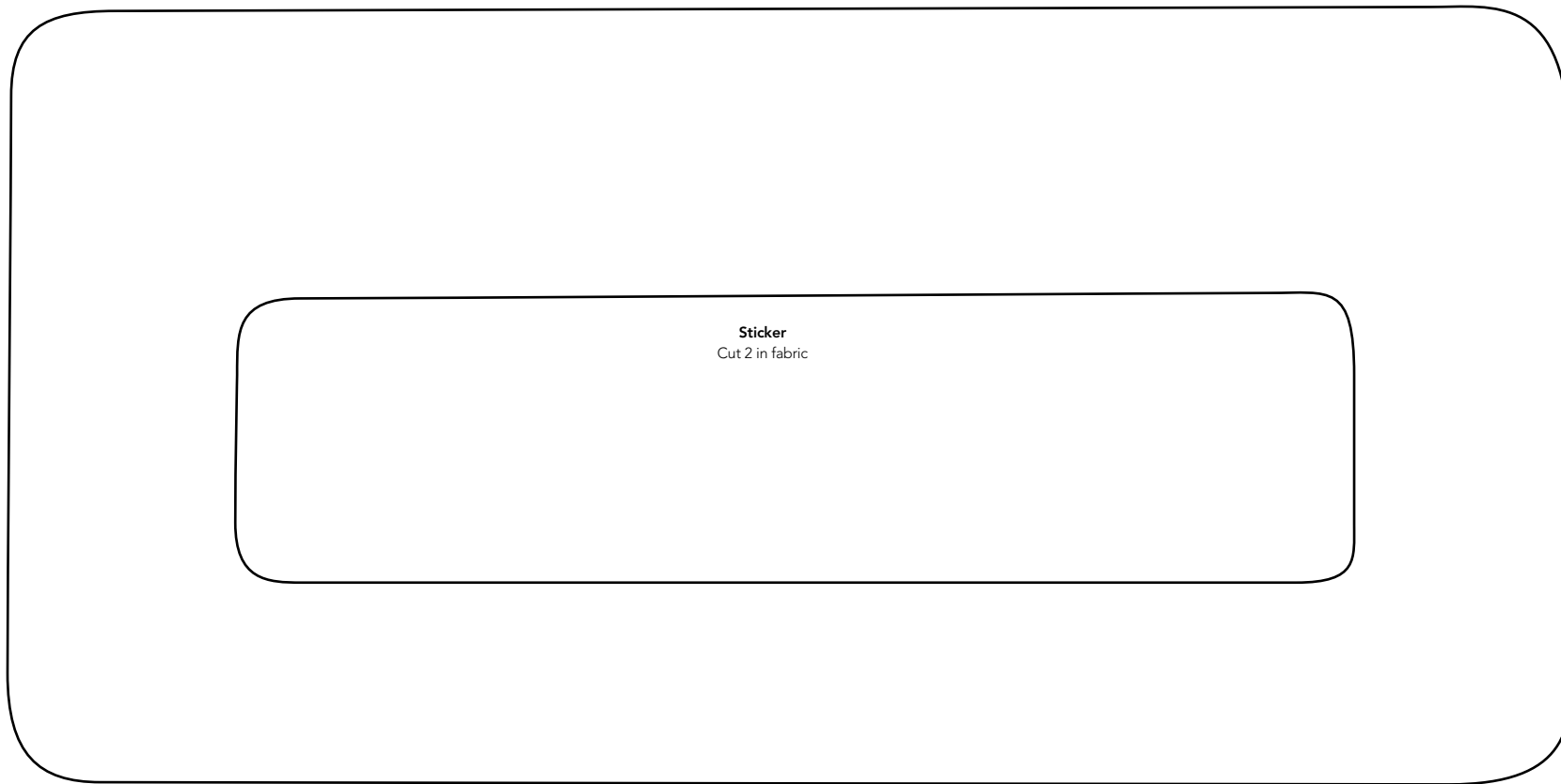

MAKE ME A MIXTAPE

By Laura Howard Page 20

iPad version

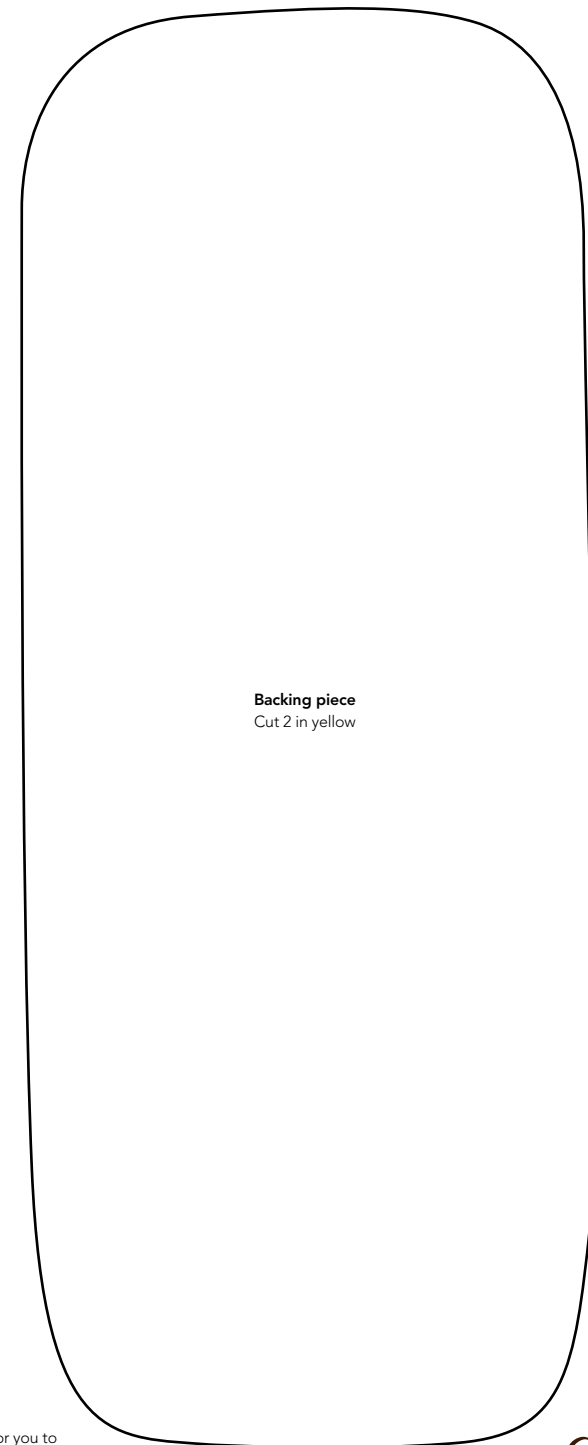
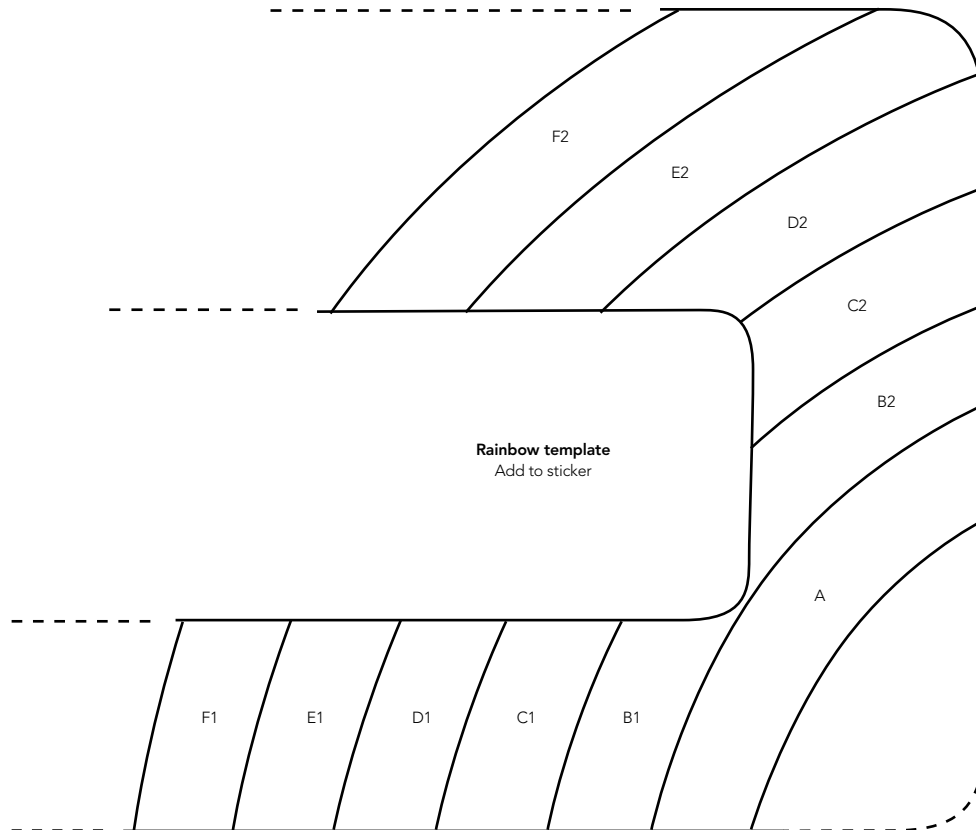

STENCIL T-SHIRT

By Alyssa Zukas Page 16

Stencil section 1

Join together with sections 2 & 3 (on next two pages) to make complete stencil

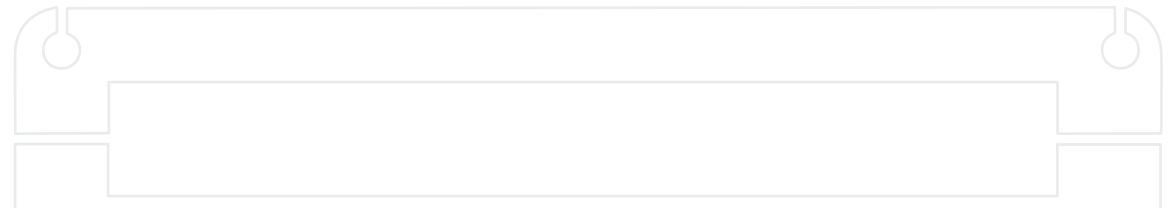
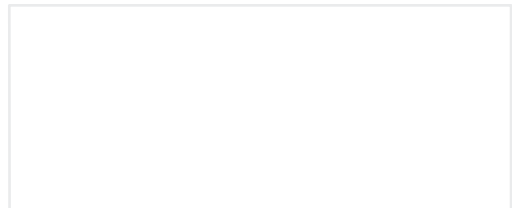
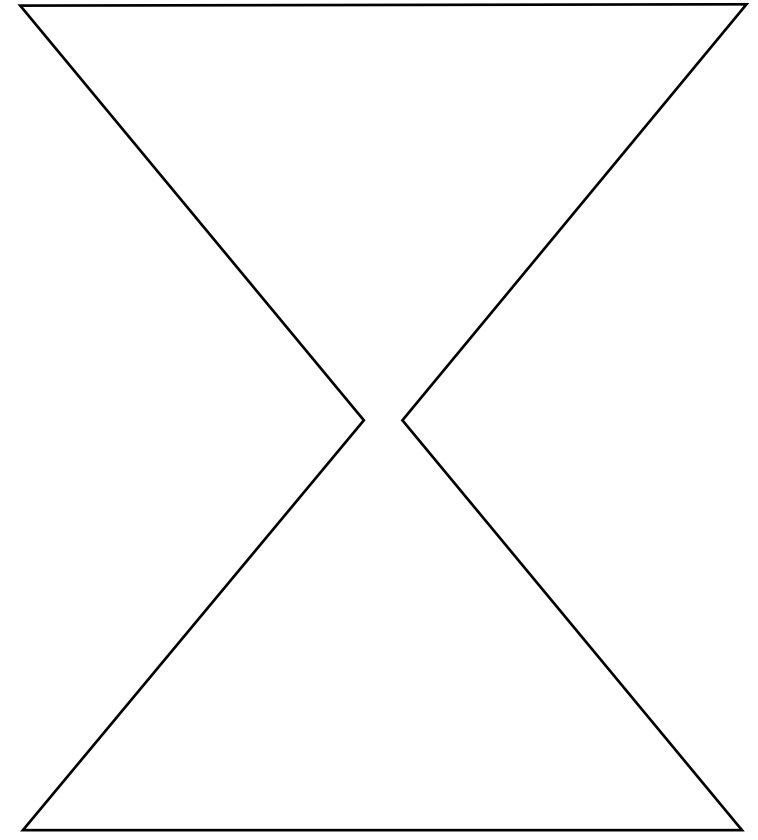
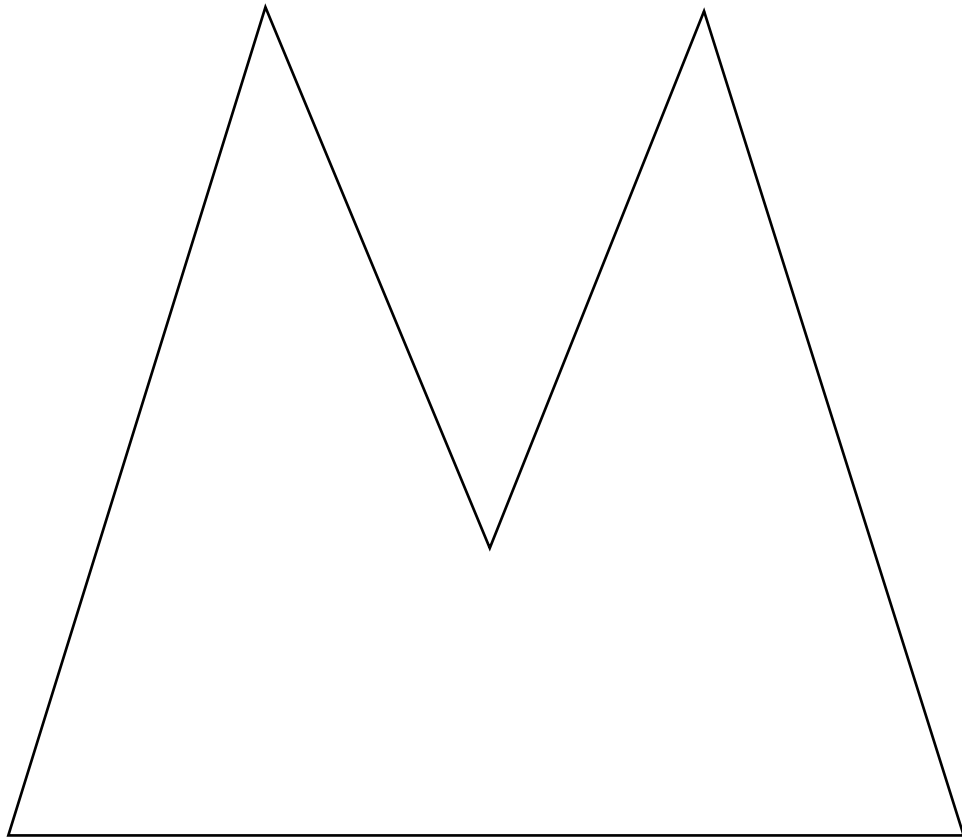

STENCIL T-SHIRT

By Alyssa Zukas Page 16

Stencil section 2

Join together with sections 1 & 3 (on previous and next pages) to make complete stencil

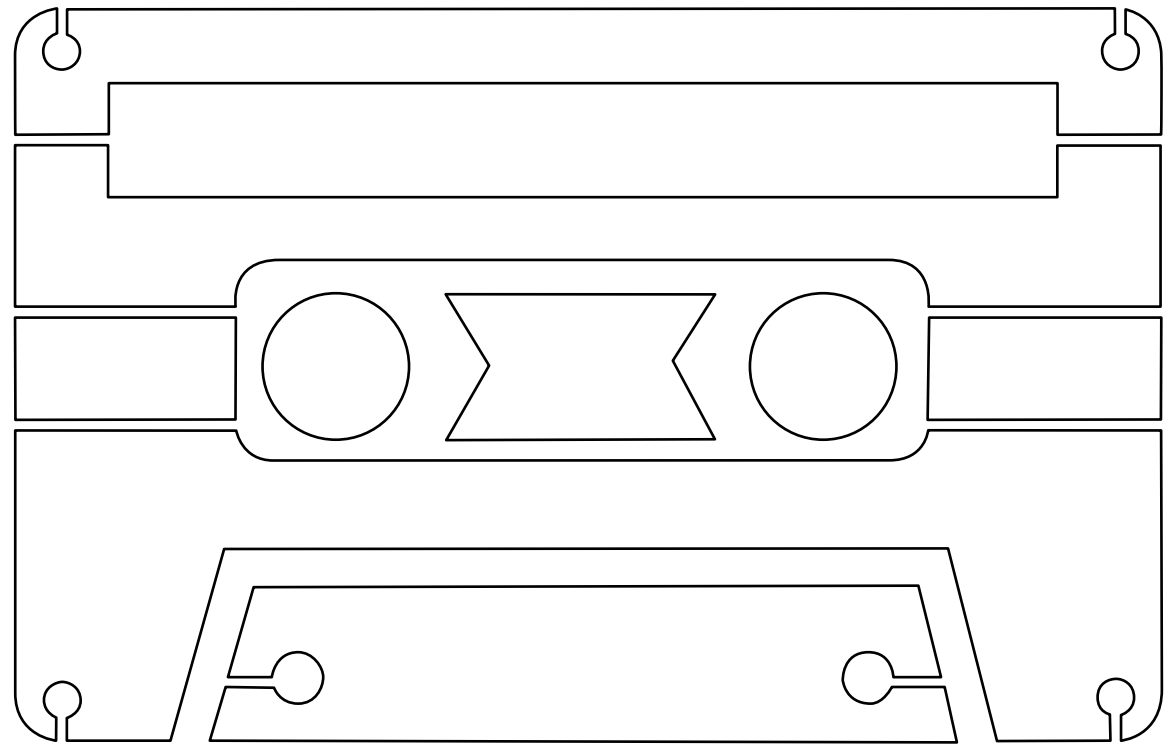
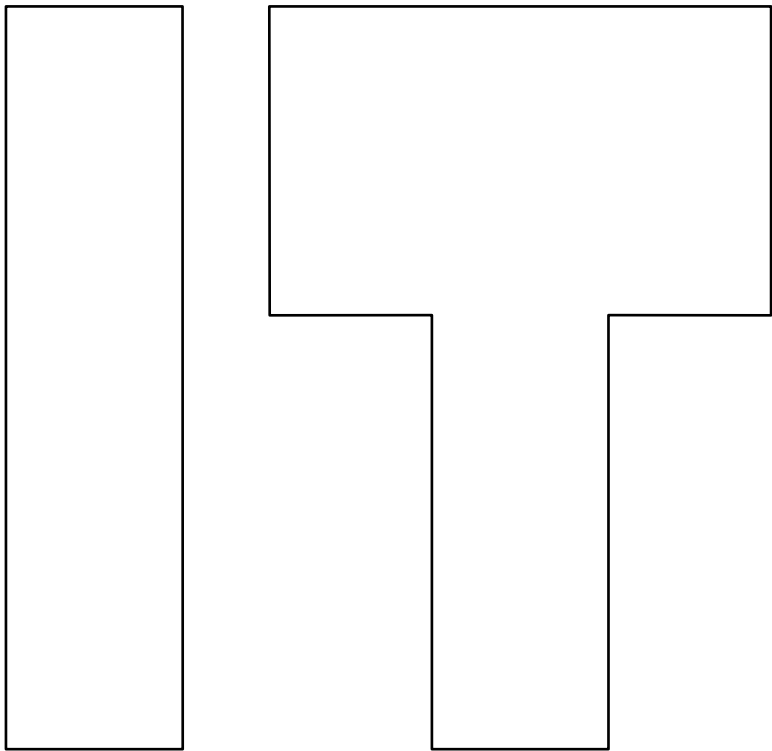

STENCIL T-SHIRT

By Alyssa Zukas Page 16

Stencil section 3

Join together with sections 1 & 2 (on previous two pages) to make complete stencil

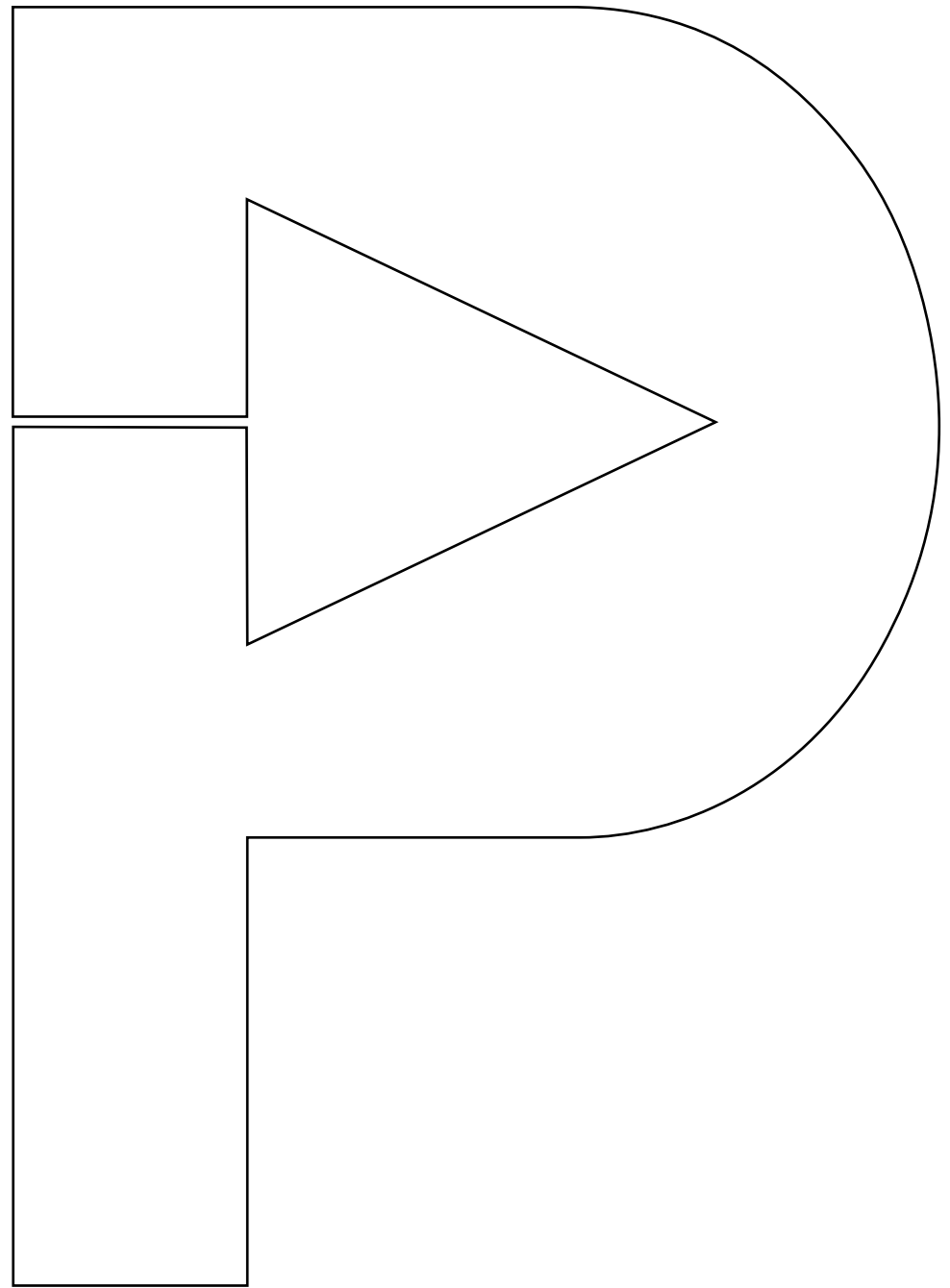
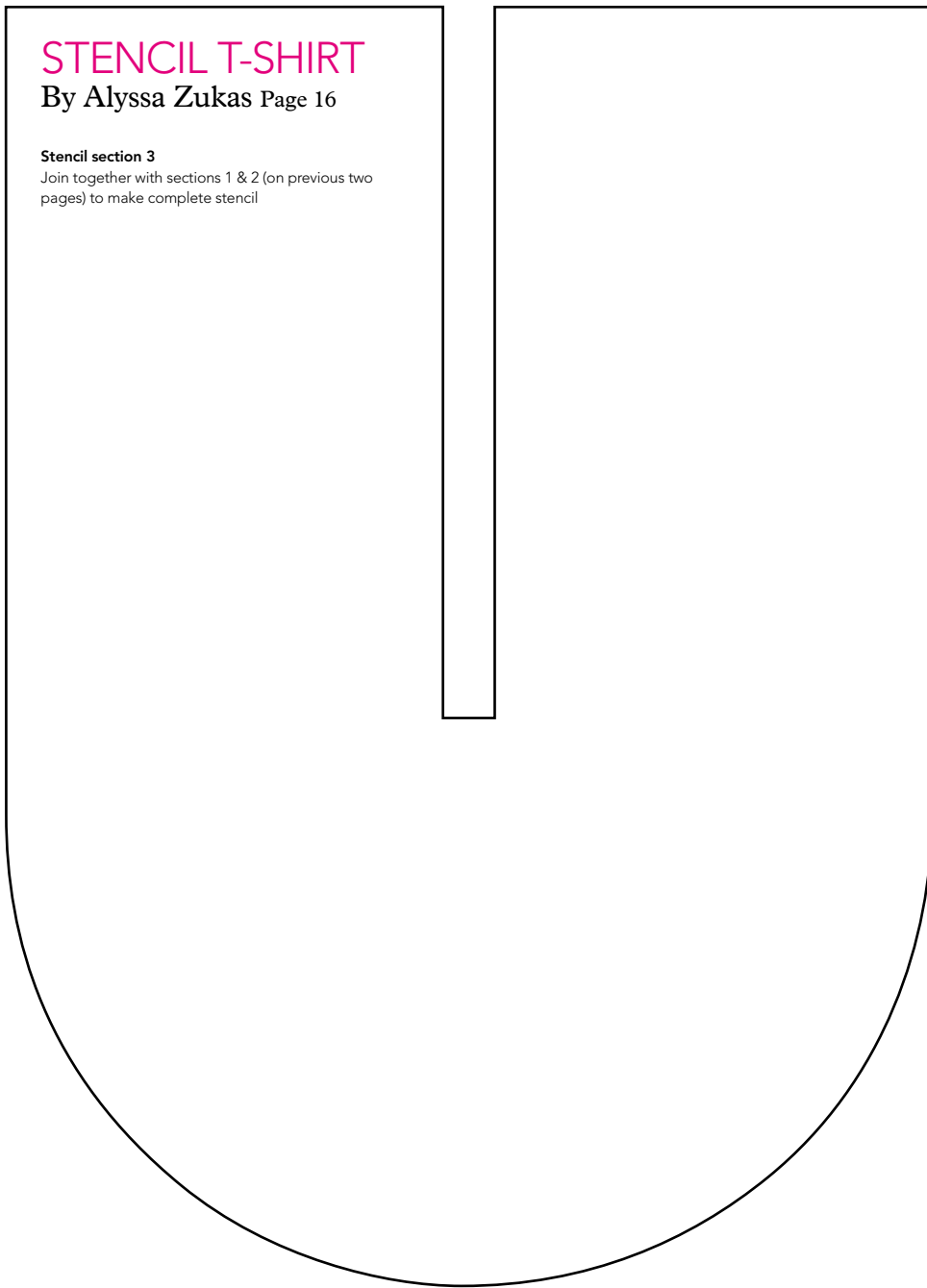

PAMPER TIME

By Boutique-Sha Page 67

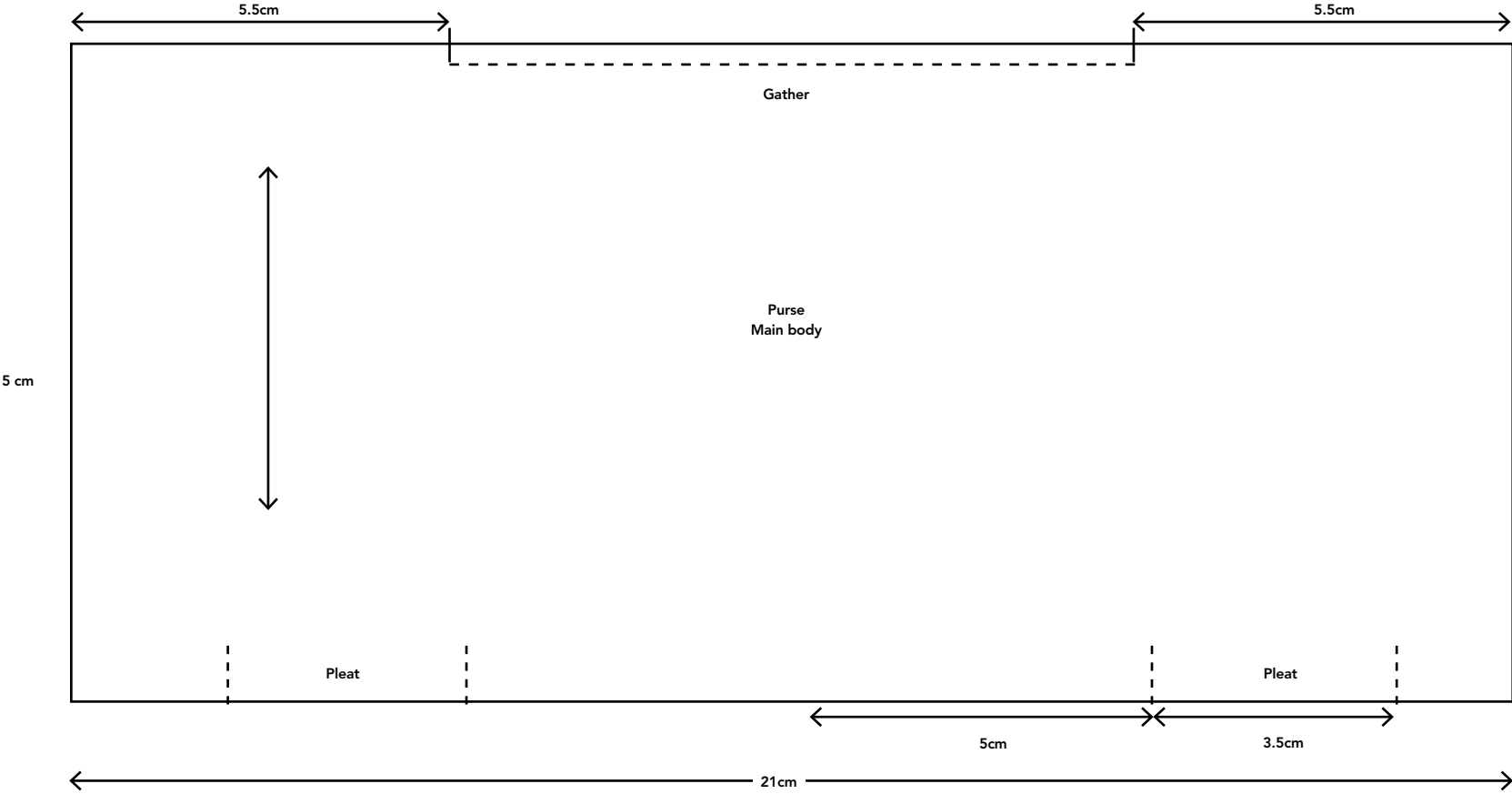

PAMPER TIME

By Boutique-Sha Page 67

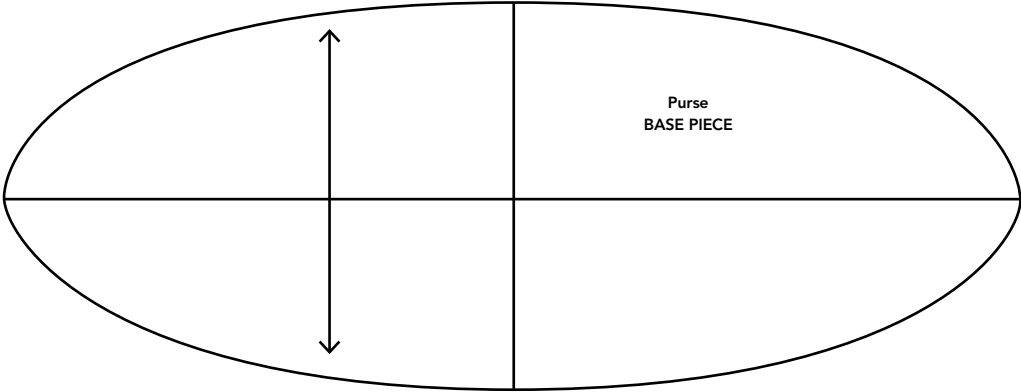
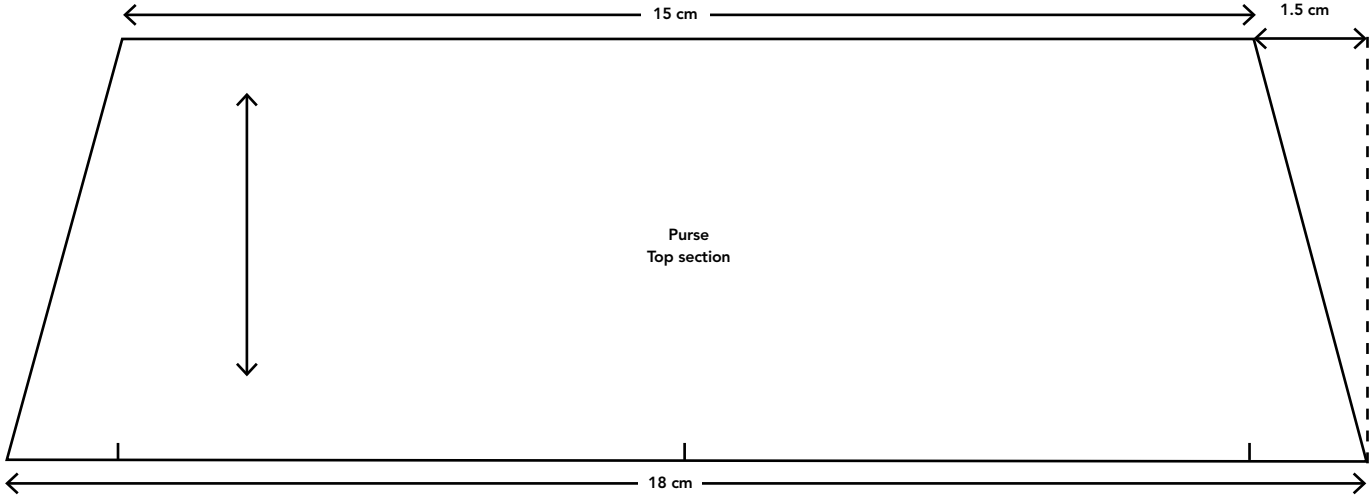

JUST A NOTE TO SAY...

By Live It Love It Make It Page 45

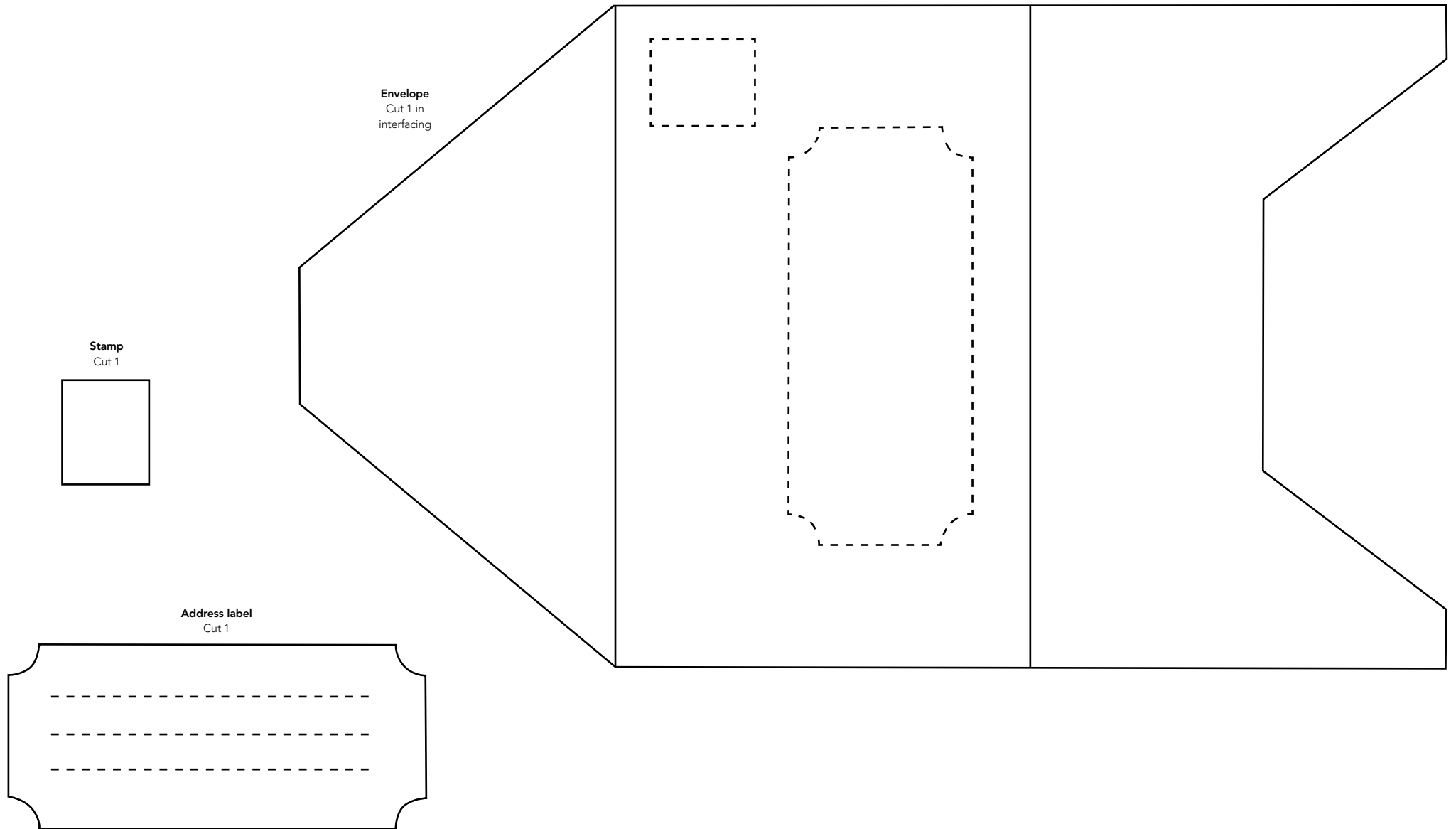

JUST A NOTE TO SAY...

By Live It Love It Make It Page 45

Letters
Cut 3 in white

♥ Dearest
Friend

Congratulations

Love from
me ♥

| |
|--|
| |
| |