

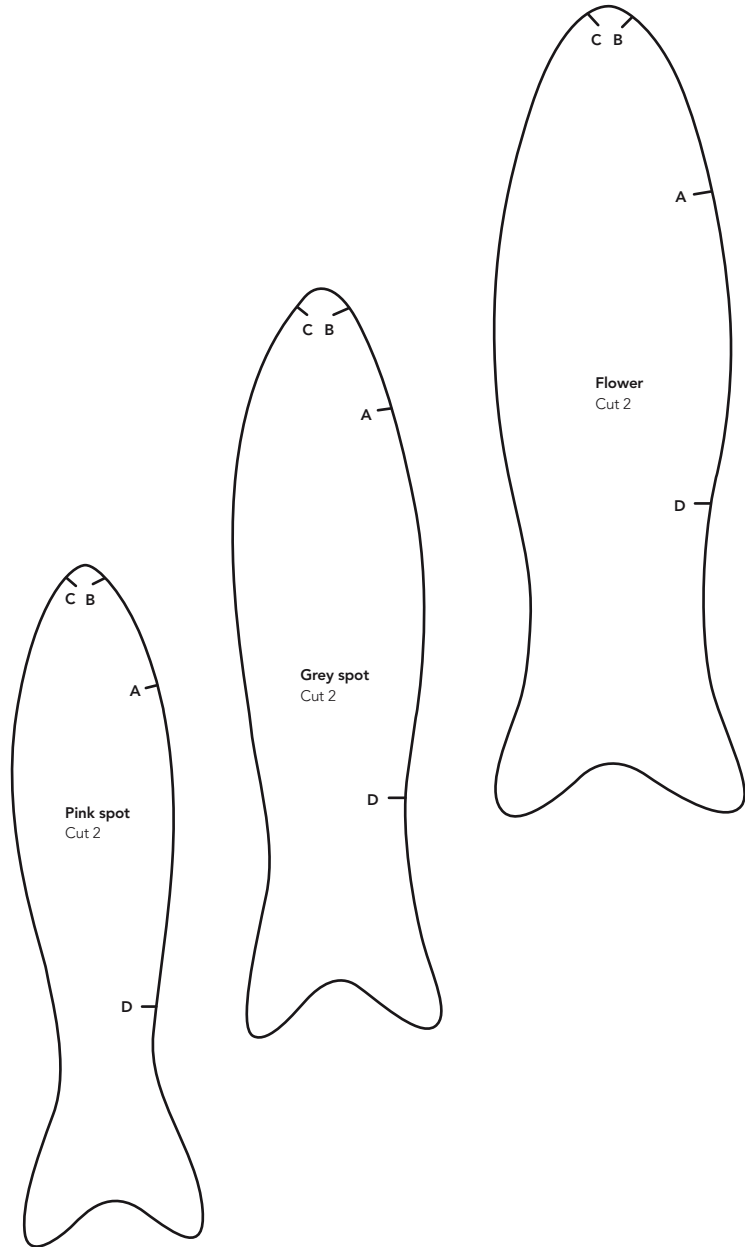

TEMPLATES ISSUE 29

SARDINE KEYRING

by Zoe Patching Free gift



BELLE & BOO FELT CAMERA BAG

By Lucinda Ganderton and Lisa Pendreigh Page 70

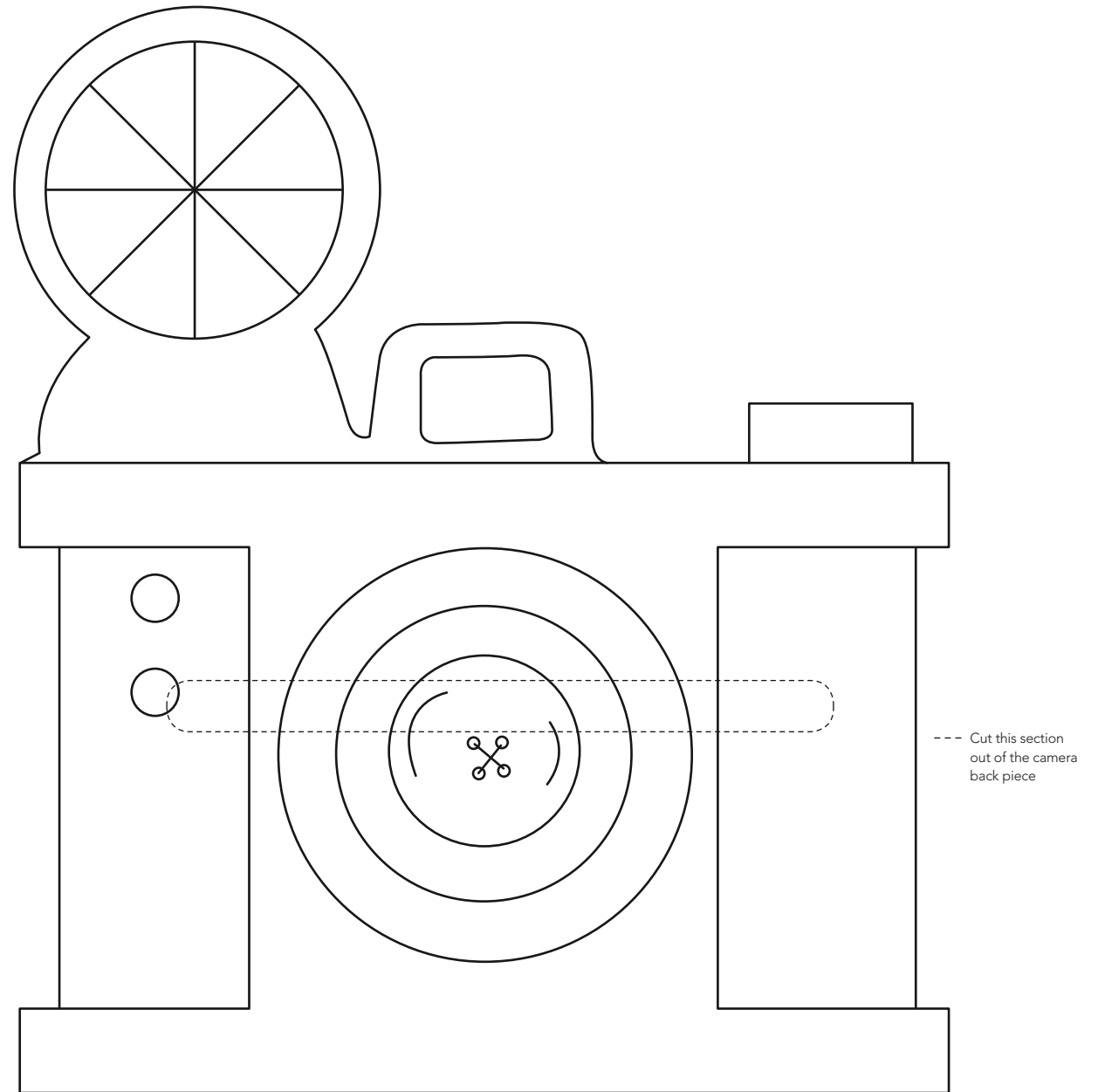

SUNDAY SHOPPER

By Emma Curtis and Elizabeth Parnell Page 65

Part 1

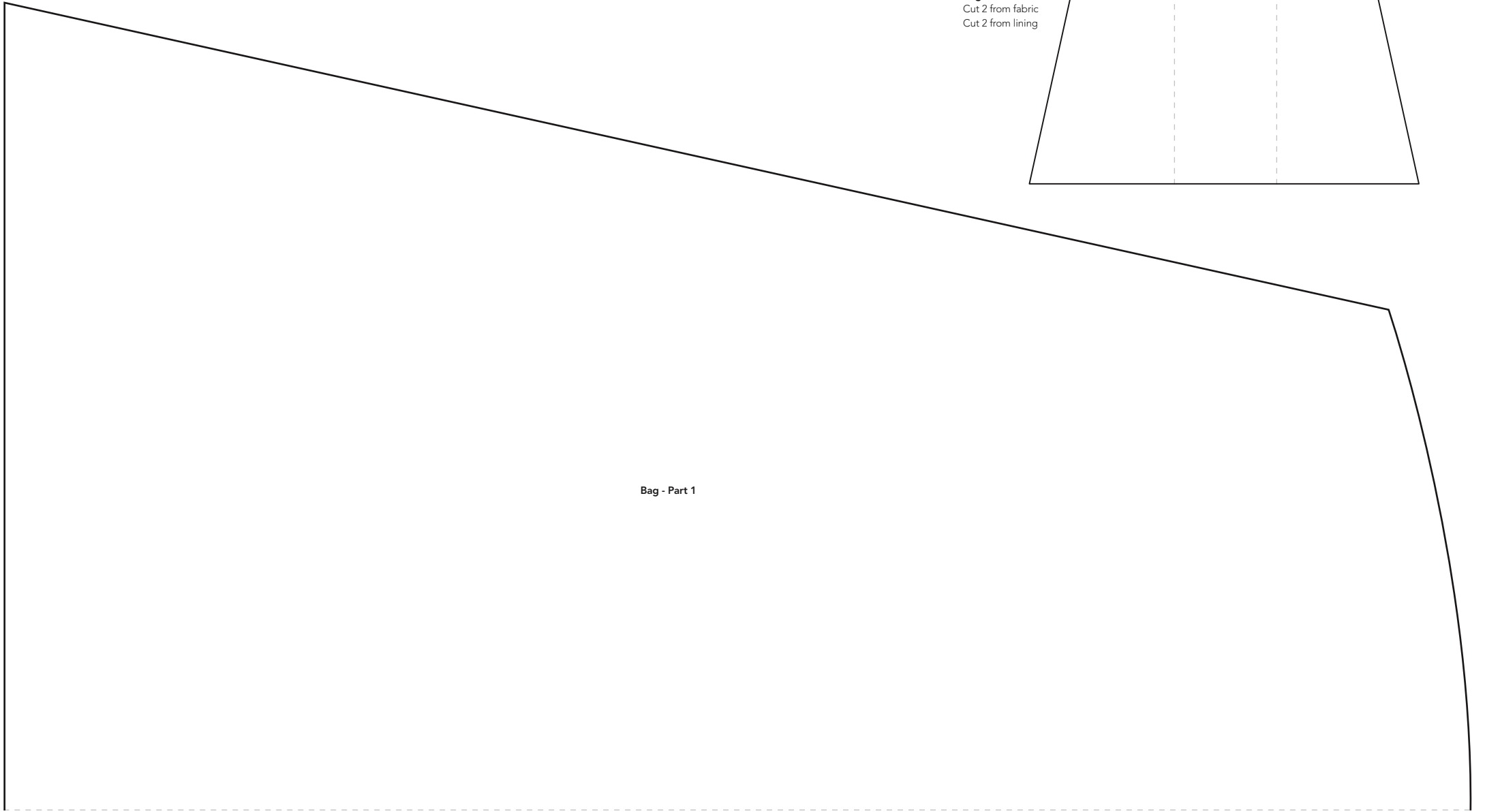

Bag
Cut 2 from fabric
Cut 2 from lining

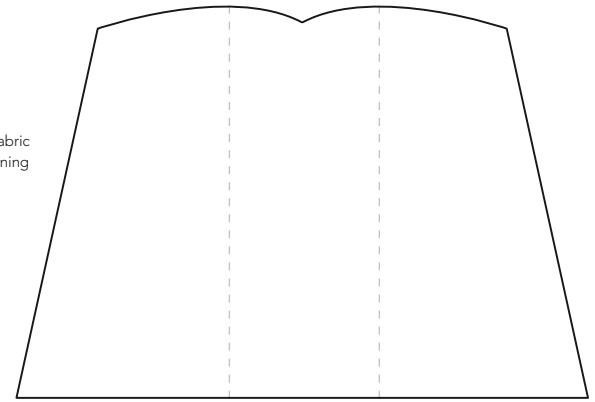

SUNDAY SHOPPER

By Emma Curtis and Elizabeth Parnell Page 65

Part 2



Bag - Part 2

SUNDAY SHOPPER

By Emma Curtis and Elizabeth Parnell Page 65

Part 3

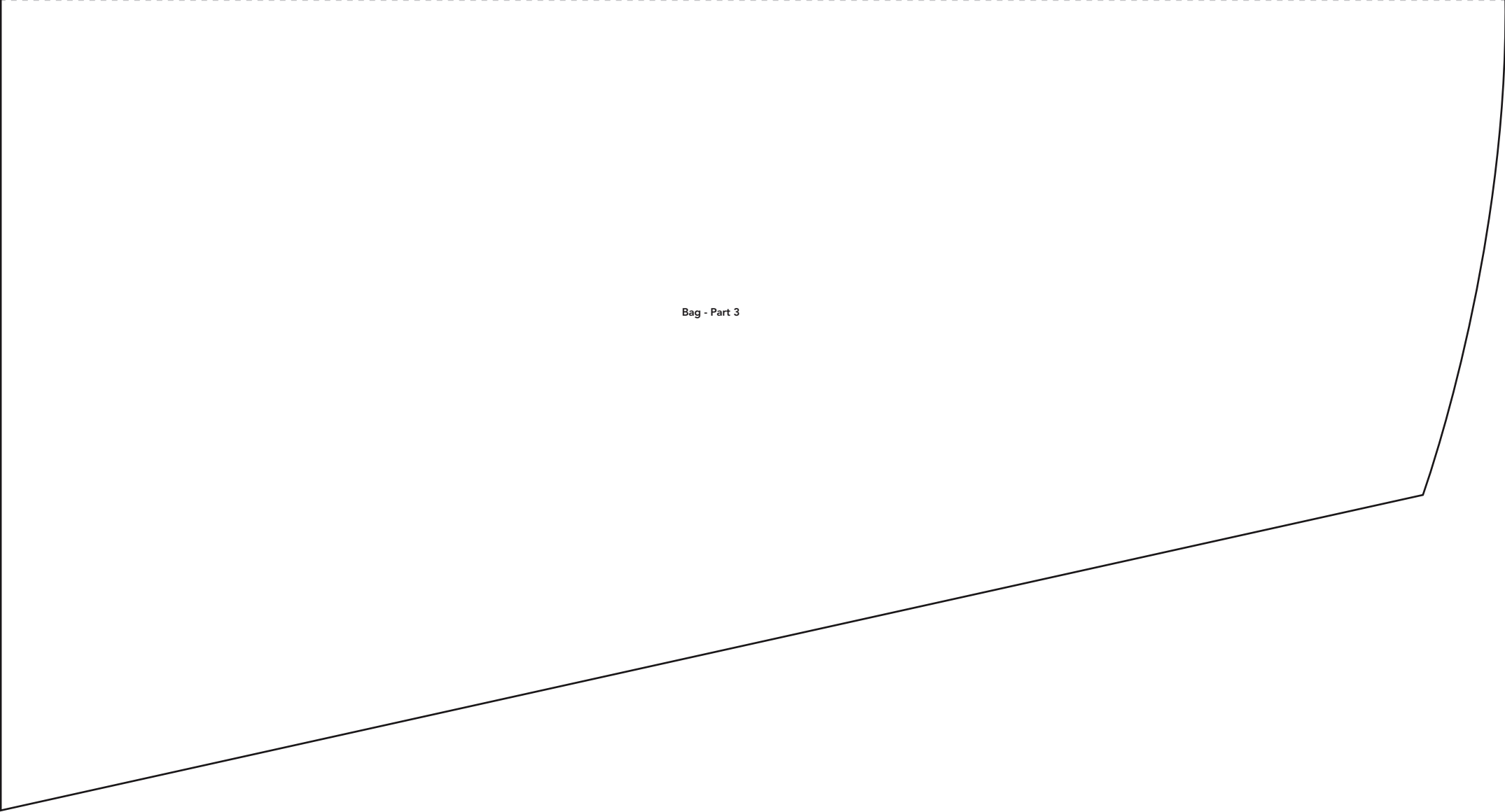

Bag - Part 3

FELT LOLLIES

By Zoe Larkins Page 26

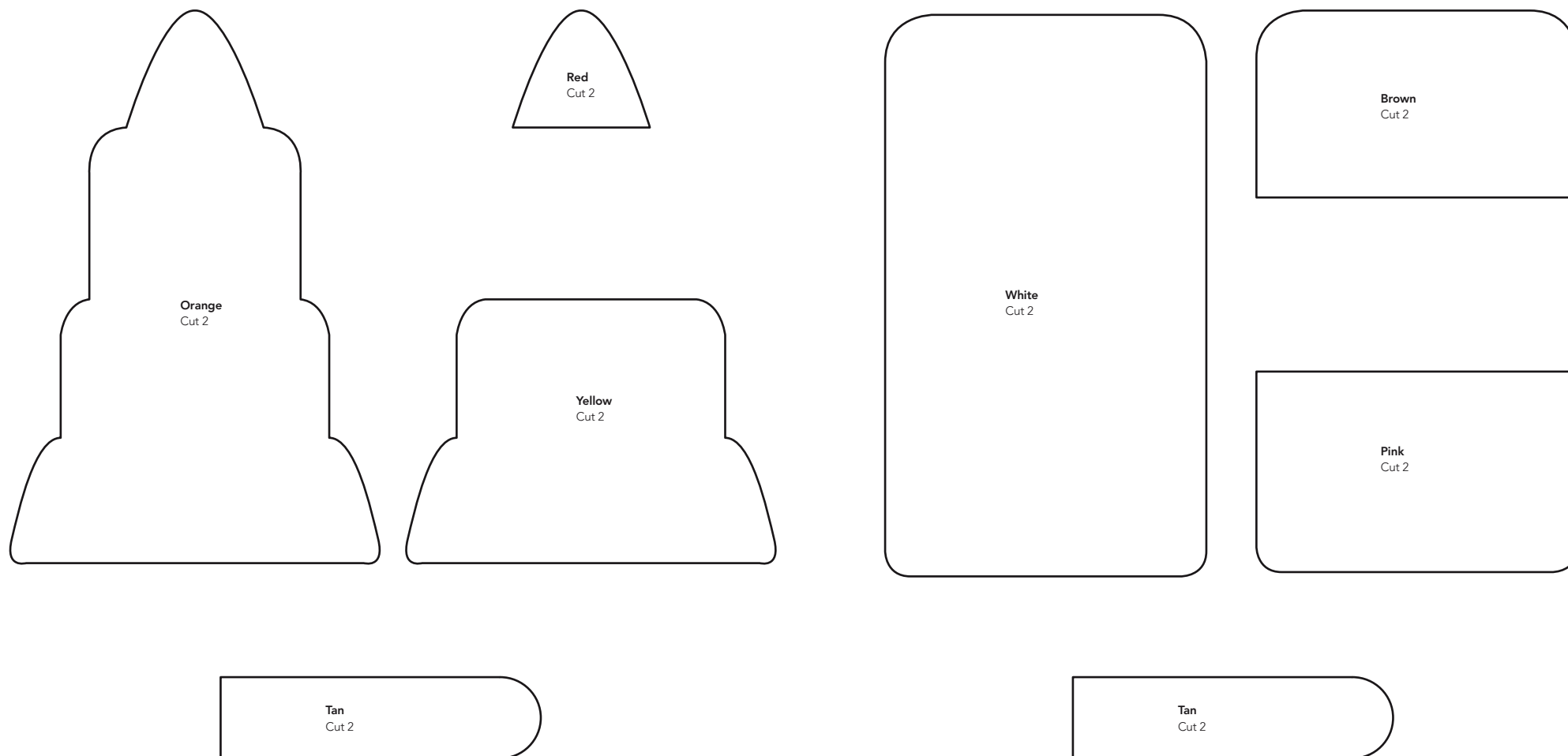

TOPSY TURVY DOLL

By Abby Glassenberg Page 41

Seam allowances shown

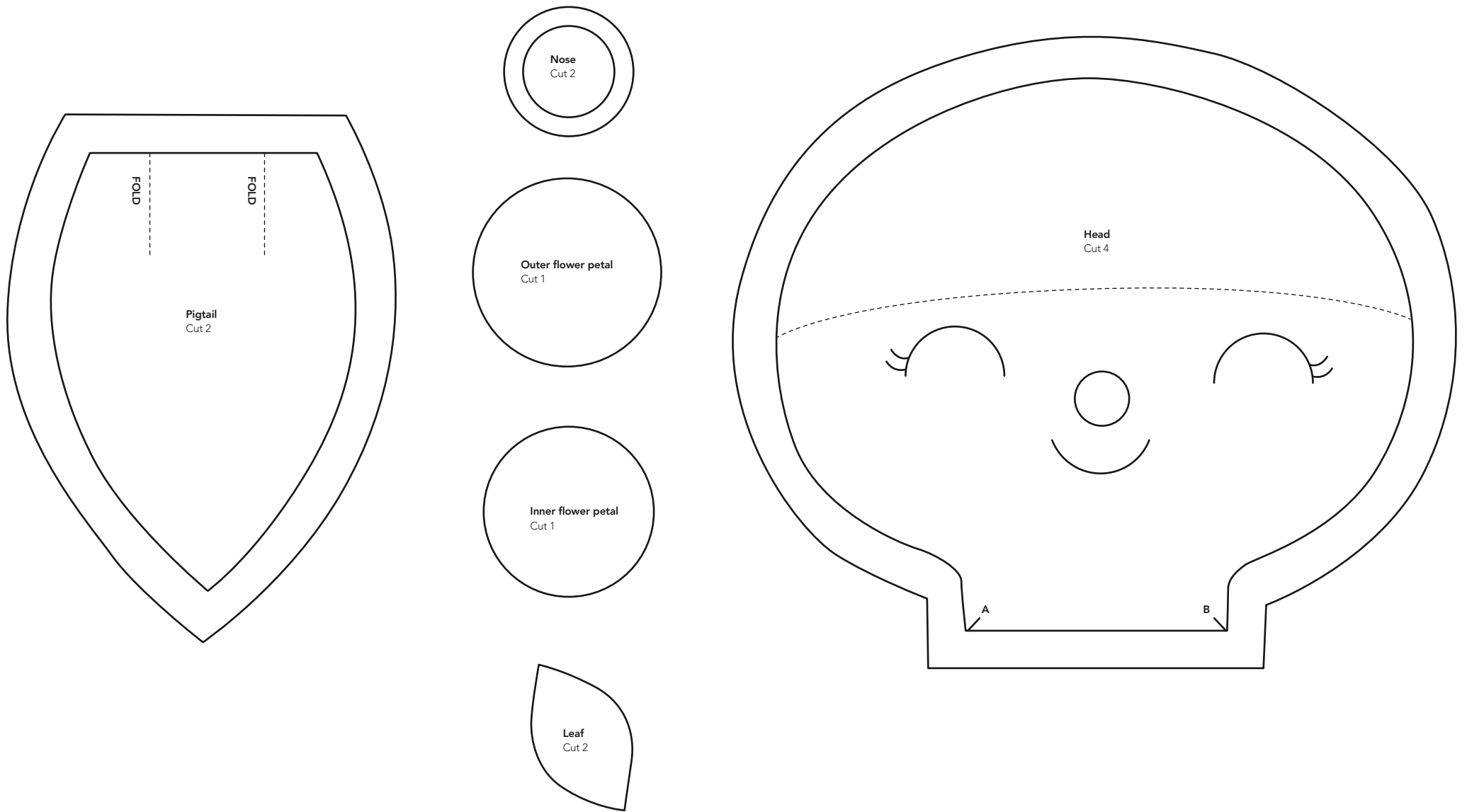

TOPSY TURVY DOLL

By Abby Glassenberg Page 41

Seam allowances shown

